

U.S. Department of Justice
Civil Rights Division
Disability Rights Section



NOTICE

Portions of this addendum may not fully reflect the current ADA regulations. The [regulation implementing title II](#) of the ADA was revised as recently as 2016. Revised [ADA Standards for Accessible Design \(2010 Standards\)](#) were issued on September 15, 2010 and went into effect on March 15, 2012.

Americans with Disabilities Act

ADA Checklist for Emergency Shelters

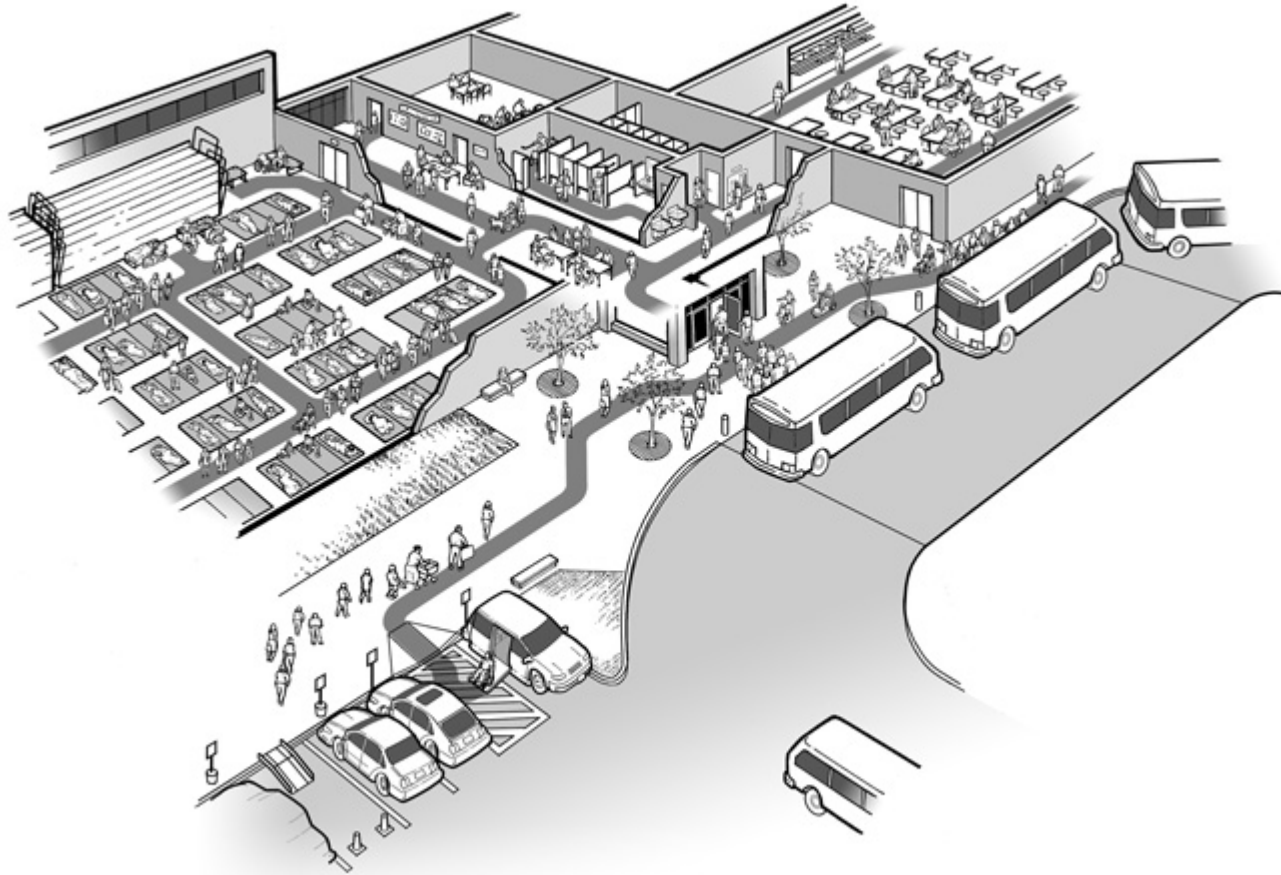

July 26, 2007

Reproduction

Reproduction of this document is encouraged. Additional copies of this publication may be obtained, viewed or downloaded from the Publications section of the ADA Website (www.ada.gov) or by calling the ADA Information Line at 800-514-0301 (voice), 800-514-0383 (TTY).

Disclaimer

The ADA authorizes the Department of Justice to provide technical assistance to individuals and entities that have rights or responsibilities under the Act. This document provides informal guidance to assist you in understanding the ADA and the Department's regulation. However, this technical assistance does not constitute a legal interpretation of the statute.

[ADA Checklist for Emergency Shelters](#)

A. Evaluating the Physical Accessibility of Emergency Shelters

B. Conducting Accessibility Survey

C. Getting Started

D. Tools Needed

E. Taking Measurements

1. Sloped Surfaces

2. Using the Tape Measure

3. Measuring Door Openings

F. Taking Photographs

G. Completing the Survey and Checklist

H. After Completing the Survey and Checklist

[Step One: Accessible Shelter Quick-Check Survey](#)

Selecting Sites to Survey for Accessibility

- A. Accessible Entrance
- B. Accessible Routes To All Service/Activity Areas
- C. Accessibility within Toilet Rooms

[Step Two: Ada Checklist For Emergency Shelters](#)

Getting to the Emergency Shelter

- A. Passenger Drop-Off Areas
- B. Parking
 - 1. Typical Issue
 - 2. Parking Spaces Checklist
 - 3. Temporary Solutions for Emergency Sheltering - Parking
- C. Sidewalks and Walkways

1. Typical Issues for Individuals Who Use Wheelchairs, Scooters, or other Mobility Devices

Accessible Ramp Features

Temporary Solutions For Emergency Sheltering - Ramps

2. Typical Issues for Individuals Who Are Blind or Have Low Vision

Temporary Solutions For Emergency Sheltering - Protruding Object Hazards

D. Entering the Emergency Shelter

Building Entrance

E. Hallways and Corridors

1. Typical Issues for Individuals Who Use Wheelchairs, Scooters, or Other Mobility Devices

2. Typical Issues for People Who are Blind or Have Low Vision

F. Check-In Areas

[Living at the Emergency Shelter](#)

G. Sleeping Areas

H. Restrooms and Showers

Toilet Stalls

I. Public Telephones

J. Drinking Fountains

K. Eating Areas

Other Issues

L. Availability of Electrical Power

M. Single-User or “Family” Toilet Room

N. Health Units/Medical Care Areas

O. Accessible Portable Toilets

Accessible Emergency Shelters

One of the most important roles of State and local government is to protect people from harm, including helping people obtain food and shelter in major emergencies. When disasters occur, people are often provided safe refuge in temporary shelters located in schools, office buildings, tents, or other facilities. Advance planning for an emergency shelter typically involves ensuring that the shelter will be well stocked with basic necessities, such as food, water, and blankets. Planning should also involve ensuring that these shelters are accessible to people with disabilities. Making emergency sheltering programs accessible is generally required by the Americans with Disabilities Act of 1990 (ADA).

A. Evaluating the Physical Accessibility of Emergency Shelters

In order to be prepared for an emergency that requires sheltering, accessible features should be part of an emergency shelter. A first step to providing an accessible shelter is to identify any physical barriers that exist that will prevent access to people with disabilities. One good way to do this is to inspect each shelter facility that your community plans to use in an emergency and identify barriers to people with disabilities, including people who use wheelchairs or scooters or who have difficulty walking, people who are deaf or hard-of-hearing, and people who are blind or who have low vision. Facilities built or extensively altered since the ADA went into effect in 1992 may have few barriers to accessibility and could be good choices for emergency shelters. Facilities built before 1992 and not altered to provide accessibility may have barriers that prevent access to people with disabilities.



When evaluating physical accessibility in older facilities, it may be a good idea to do the analysis in two parts. If you suspect that an older facility is not accessible, you can do a preliminary analysis before completing a detailed accessibility survey. This preliminary analysis, or quick-check, can eliminate facilities with extensive barriers so that the focus can be on those facilities that are most appropriate to become accessible shelters. To help identify older buildings that may be good candidates to become accessible shelters, a copy of the Accessible Shelter Quick-Check Survey is provided on page 7. After completing the Quick-Check Survey, if you have checked “Yes” for most of the questions on the forms, you should conduct a full accessibility survey using the ADA Checklist for Emergency Shelters.

If you find barriers to accessibility after completing the checklist, the next step is to either remove the barriers or identify other nearby accessible facilities that can serve as a shelter. In communities with more than one emergency shelter, until all shelters are accessible, the locations of accessible shelters should be widely publicized, particularly to people with disabilities and organizations that serve the disability community.

B. Conducting Accessibility Surveys

The following Quick-Check Survey (beginning on page 7) and the ADA Checklist for Emergency Shelters (beginning on page 11) are designed to assist State and local officials and operators of emergency shelters to determine whether a facility being considered for use as an emergency shelter is accessible and if not, whether modifications are needed to remove barriers or whether relocation to another accessible facility is necessary. Filling out the Quick-Check Survey will provide guidance on whether a facility has certain basic accessible features, and filling out the detailed ADA Checklist for Emergency Shelters will provide specific information on any barriers to accessibility.

C. Getting Started

Individuals conducting the surveys need not be experienced in evaluating facilities for accessibility. The checklist provides guidance on how to complete the survey and will prompt the user to check key elements. The checklist pages also provide space for notes and other key information. The checklist is designed to prompt the user to check key features by asking questions about sizes, sloped surfaces, and availability of accessible features; and in some areas, it suggests alternatives if a physical barrier is identified. By following the directions provided for filling out the checklist, staff can identify accessible shelters and develop information needed to implement temporary and permanent accessibility modifications.

An evaluation of shelter accessibility should focus on those areas of the facility that may be used for providing shelter in an emergency. These include areas where people are dropped off by a bus, van, or car; the parking area; the entrance to the shelter; pedestrian routes (both exterior and interior); sleeping, eating, information, and recreational areas; and toilet rooms.

Before shelter accessibility is evaluated, it is useful for staff to review the instructions for filling out the checklist and become familiar with the questions. It is also helpful to practice taking measurements, photographs, and recording information. On the day of the survey, it is helpful to first become familiar with certain areas before starting to record information. Upon arrival at the proposed shelter, first find the areas where people will disembark from vehicles, both passenger drop-off and loading zones as well as parking areas. Next find the entrances to the shelter areas that will be used during an evacuation. If possible, take an identifying “location” photograph that shows the name of the facility and the address so that other photographs can be identified correctly. When inside the building, locate the areas where people are likely to register, sleep, and eat. Locate the toilet rooms that serve the shelter area. It is also a good idea to locate any areas used for telephones, food distribution, and medical services.

D. Tools Needed

The following items are needed for the survey:

- A metal tape measure that is at least 20 feet long;
- A digital level or bubble level that is 24 inches long;
- A door pressure gauge;
- A digital (preferred) or film camera with a flash;
- One copy of the checklist for each shelter (and Quick-Check Survey if used); and
- A clipboard and pens.

If you are not familiar with taking the types of measurements needed to complete the checklist, review the following section and practice using the tools before going to conduct a survey.

E. Taking Measurements

1. Sloped Surfaces

Measuring the slope of a ramp, parking space, walkway, or other ground or floor surface is important to identify whether the surface is accessible. The amount of slope or grade is described as the proportion of a vertical rise to a horizontal length. It is usually described as:

- a ratio (e.g., 1:20, which means one unit of vertical rise for each 20 units of horizontal length); or
- a percentage (e.g., 8.33% which equates to a ratio of 1:12 or 4.76 degrees).

The easiest way to measure slope is to use a digital level. The digital display gives a reading that may be shown as a percent, degrees, or as a digital bubble. Before using a digital level, make sure to understand the directions for its use. It will need to be calibrated before each use. The maximum running slope generally allowed for ramps is 1:12 (8.33% or 4.76 degrees). Cross slope is the slope or grade of a surface perpendicular to the running slope. The most cross slope allowed on an accessible route is 1:50 (2% or 1.15 degrees).

Another way to measure slope that requires more effort is to use a 24-inch level with leveling bubble and a metal tape measure. Place the level on the sloped surface in the direction you wish to measure. Rest one end of the level at the highest point of the sloped surface and lift the other end (see below) until the bubble is in the middle of the tube. This is the “level” position. While the level is in this position, measure the distance between the end of the level and the sloped surface below. If the distance is two inches or less, then the slope is 1:12 or less. When the distance is more than two inches, record the distance on the checklist so the exact slope can be calculated later. For measuring cross slope, if the distance, measured from the level position, is ½ inch or less then the slope is 1:48 or less.

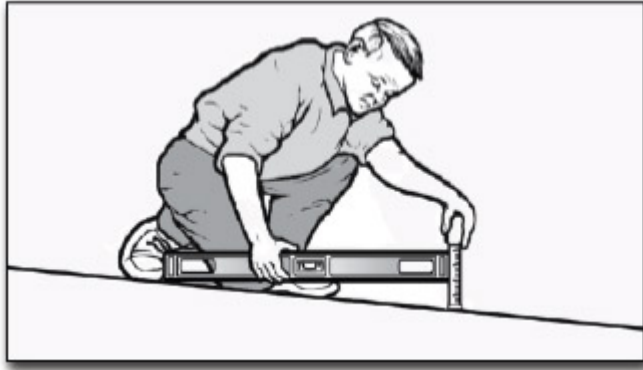

Measuring slope using a 24-inch bubble level and tape measure

2. Using the Tape Measure

A metal tape measure is needed to measure the length, width, height, and depth of various elements. When measuring long distances, pull the tape tight to get an accurate measurement. The checklist will offer guidance for the specific measurement that is required.

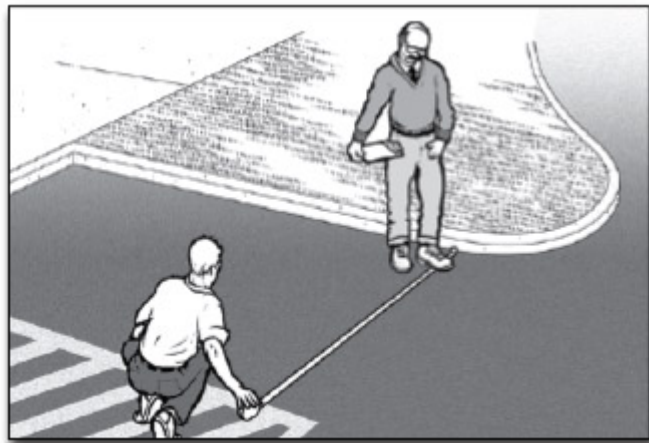

Using a tape measure to measure the width of a parking space

3. Measuring Door Openings

Special care is needed when measuring the clear opening of a doorway. To measure the clear opening of a standard hinged door, open the door to 90 degrees. Place the end of the tape measure on the side of the door frame next to the clear opening (see below). Stretch the tape across the door opening to the face of the door. This measures the clear width of the door opening through which people pass, which is less than the width of the door itself.



Measuring the clear opening from the face of the doorstop on the frame to the face of the open door

F. Taking Photographs

A comprehensive set of photographs makes it easier to understand existing conditions after the survey is completed. It is a good idea to take many photos of the exterior and interior of the potential shelter. It is likely that many other people in your decision-making process will need to review information about the facility you are surveying, so try to record each element that you survey with several photos. It is always useful to first take a photo that will clearly identify the location of the element so that others will easily be able to find the element. Then, take several close-up shots of that element to document the conditions you found during your survey. If you are not familiar with the camera that you plan to use, practice using it both indoors and outdoors before starting to survey the various facilities being considered for use as shelters. If you are using a digital camera, it is a good idea to review the images as you take them to ensure that you have good quality photographs.

G. Completing the Survey and Checklist

The survey and checklist forms will prompt you for what to look at and where to measure. You should write down all answers and notes for use later in the planning process. If a photo is taken of a particular element or condition, then you should note this on the checklist. It is usually more efficient for two or three people to work together doing these surveys. One person can measure while the other records the information and takes photos.

For each item, check either “Yes” or “No.” If the measurement or number falls short of that required for accessibility, write the measurement or number to the right of the question. Add notes or comments as needed. For some questions when “No” is the answer, the checklist will include a prompt to check for an alternate solution. Information on possible alternative solutions can be used later to decide how to better provide accessibility. Taking several photos is also helpful when the answer is “No” and an alternative way to provide accessibility is not readily apparent.

When completing the survey or checklist, try to answer every question in each section unless the element is not present at that facility. For example, if no parking lot is provided at the facility, (such as where only on-street parking is provided), do not measure the size of the on-street parking spaces.

Some sections of the checklist are divided into two parts, one for individuals with a mobility disability and the other for individuals who are blind or who have low vision. While evaluating a facility you will be checking to ensure that an accessible route is provided. The accessible route is a continuous unobstructed pedestrian path without steps or steep slopes that connects all accessible site and building features and spaces together. A continuous accessible route must be available at the shelter for people who use a wheelchair, scooter, or other mobility device. Other sections of the checklist ask questions related to individuals who are blind or have low vision. These questions cover all circulation paths, not just pedestrian paths that are also an accessible route.

The survey and the checklist are based on some of the requirements from the ADA Standards for Accessible Design (the Standards). Questions have been selected to reflect features that may be most important for the short-term stays common for emergency shelters. To learn more about the Standards, see the Department of Justice regulations, 28 C.F.R. Part 36, Appendix A. The regulations and the Standards are available at www.ada.gov. Copies are also available by calling the ADA Information Line at 800-514-0301 (voice) or 800-514-0383 (TTY).

H. After Completing the Survey and Checklist

Once you have completed the survey and filled out the checklist, you can determine which elements or spaces in a potential shelter facility are accessible and which may need modifications. If most answers are “yes,” the facility may need little or no modification. If some answers are “no,” modifications may be needed to remove barriers found in that space or element. Emergency shelters in older buildings with inaccessible features might be made accessible with temporary modifications, (such as portable ramps at the entrance

and accessible parking spaces marked off by traffic cones) until permanent modifications can be made. However, where facilities are not capable of being made accessible, another facility will need to be selected for use as a shelter.

Step One: Accessible Shelter Quick-Check Survey

Selecting Sites to Survey for Accessibility

Providing an emergency shelter that is accessible to people with disabilities involves making sure that a number of accessible features and spaces are available. To verify accessibility before deciding on a site for an emergency shelter can involve asking many questions such as those in the ADA Checklist for Emergency Shelters. For some older buildings, especially those on hilly sites and those that have not been renovated, remodeled, or altered since 1992, before completing the detailed checklist, it may be better to do a pre-test that can rule out a facility with major accessibility problems so available resources can be focused on other locations. The following questions will help evaluate whether a facility has such major accessibility barriers. After this first step, buildings that do not have major accessibility problems should be surveyed more thoroughly, using the ADA Checklist for Emergency Shelters, to find out which, if any, barriers need to be removed to provide an accessible shelter.

A. Accessible Entrance

Having a way to get into the emergency shelter on a surface that is firm, stable, slip resistant, without steps or steep slopes, and wide enough for a person using a wheelchair or other mobility aid is essential.

A1. Is there a sidewalk connecting the parking area and any drop off area to the walkway leading to the building? [ADA Standards § 4.1.3(1)]

Yes

No

A2. Is there a route without steps from this sidewalk to the main entrance?

Yes

No

If No, are there two or fewer steps? Yes ____ No ____ Number of Steps: _____

If No, is there another entrance without steps that is connected by a sidewalk to the parking or drop off area? Yes ____ No ____ Location: _____

B. Accessible Routes To All Service/Activity Areas

Everyone must be able to get to each of the various areas where activities and services take place. This includes people who use mobility devices, such as wheelchairs and scooters, being able to get to locations where supplies are distributed, to eating areas, to sleeping areas, to toilet rooms, and to other activity areas without encountering stairs or steep slopes.

Check all of the various ways to get to each of the areas where sheltering activities are likely to take place (sleeping, eating,

B1. Sleeping Area (Location: _____)

B1-a. Is there a route without steps from the accessible entrance to this location?

Yes

No

If No, are there two or fewer steps? Yes ____ No ____ Number of Steps: _____

If No, is there a ramp, lift, or elevator? Yes ____ No ____ Type of device: _____

B1-b. If an elevator or lift provides the only accessible route, is there a source of backup power to operate the device for an extended period?

Yes

No

B2. Eating Area (Location: _____)

B2-a. Is there a route without steps from the accessible entrance to this location?

Yes

No

If No, are there two or less steps? Yes ___ No ___ Number of Steps: _____

If No, is there a ramp, lift, or elevator? Yes ___ No ___ Type of device: _____

B2-b. If an elevator or lift provides the only accessible route, is there a source of back up power to operate the device for an extended period?

 Yes No

B3. Supply Distribution Area (Location: _____)

B3-a. Is there a route without steps from the accessible entrance to this location?

 Yes No

If No, are there two or fewer steps? Yes ___ No ___ Number of Steps: _____

If No, is there a ramp, lift, or elevator? Yes ___ No ___ Type of device: _____

B3-b. If an elevator or lift provides the only accessible route, is there a source of backup power to operate the device for an extended period?

 Yes No

B4. Toilet Rooms (Location: _____)

B4-a. Is there a route without steps from the accessible entrance to this location?

 Yes No

If No, are there two or fewer steps? Yes ___ No ___ Number of Steps: _____

If No, is there a ramp, lift, or elevator? Yes ___ No ___ Type of device: _____

B4-b. If an elevator or lift provides the only accessible route, is there a source of backup power to operate the device for an extended period?

Yes

No

C. Accessibility Within Toilet Rooms

C1-a. Is there an area within the toilet room where a person who uses a wheelchair or mobility device can turn around - either a minimum 60-inch diameter circle or a "T"-shaped turn area? [ADA Standards §§ 4.22.3; 4.2.3, Fig. 3]

Yes

No

C1-b. Is at least one stall at least 60 inches wide and 56 inches deep (wall mounted toilet) or 59 inches deep (floor mounted toilet)? [ADA Standards § 4.17.3]

Yes

No

Using The Information:

If most of your answers to the previous questions are Yes, then the facility has some basic accessibility features and should be surveyed using the ADA Checklist for Emergency Shelters. Whenever most of your answers are No, then these problems should be evaluated before conducting a more detailed survey, or perhaps you should consider another location to serve as an emergency shelter.

Step Two - ADA Checklist For Emergency Shelters

Getting to the Emergency Shelter

A. Passenger Drop-Off Areas

During an evacuation the most efficient method of transporting people to shelters likely will include using vans and buses. Accessible buses and vans with wheelchair lifts will be needed to transport people who use wheelchairs, scooters, or other mobility aids. When they arrive at the shelter, an accessible drop-off area (also known as a passenger loading zone) is needed for people using mobility aids to get off of the bus or van and proceed to the shelter's accessible entrance.

An accessible drop-off area must have a level access aisle that is adjacent and parallel to the vehicle space. Where a curb separates the vehicle space from the access aisle or the access aisle from an accessible route, a curb ramp must be provided so people with mobility disabilities can get to the accessible route leading to the accessible entrance of the shelter.

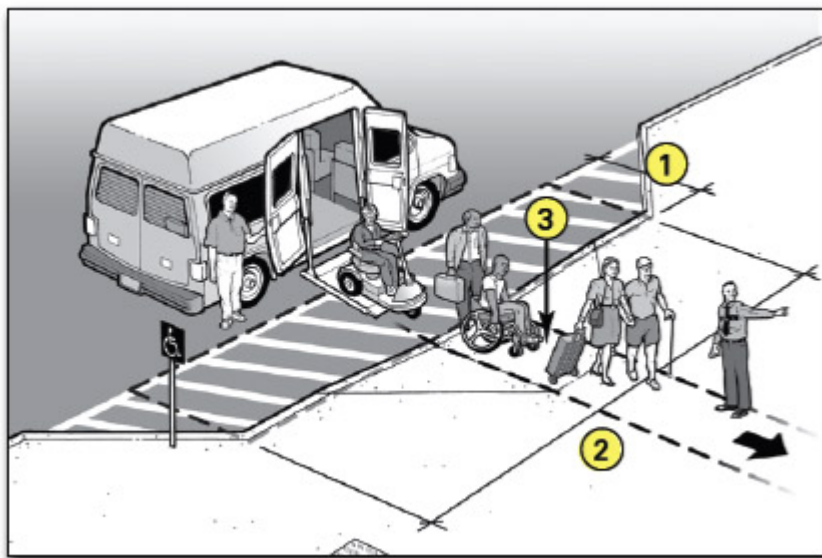

Accessible drop-off area with an access aisle provided at the same level as the vehicle.

Notes

1. Access aisle depth is at least 5 feet.
2. Access aisle length is at least 20 feet. 3.
3. Curb ramp connects the access aisle for the accessible drop-off area (which is at the level of the parking lot) to the accessible route to the accessible entrance of the shelter.

The access aisle may be at the parking-lot level or at sidewalk level. If the access aisle is at the parking-lot level, the curb ramp is provided between the access aisle and the sidewalk. If it is at the sidewalk level, an adjacent curb ramp is provided between the street and the sidewalk.

A1. Is a relatively level (1:50 or 2% maximum slope in all directions) access aisle provided adjacent and parallel to the side of the vehicle pull-up area?

[ADA Standards § 4.6.6]

Yes

No

If No, look for another relatively level location that is on an accessible route to the accessible shelter entrance that could be used.

A2. Is the vehicle pull-up area relatively level (1:50 or 2% maximum slope in all directions)?

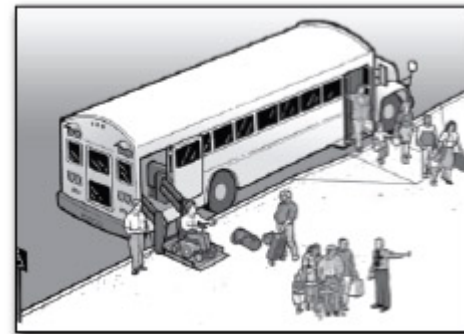

Accessible drop-off area with an access aisle provided as part of the sidewalk.

Yes

No

A3. Is the area for the access aisle at least 5-feet wide and 20-feet long? [ADA Standards § 4.6.6].

Yes

No

Note: Unlike at an accessible parking space, the surface for the access aisle of an accessible passenger drop-off area does not have to be marked or striped.

A4. Is there vertical clearance of at least 114 inches (9 feet 6 inches) from the site entrance to the vehicle pull-up area, the access aisle, and along the vehicle route to the exit? [ADA Standards § 4.6.5]

Yes

No

A5. Is a curb ramp provided between the vehicle pull up area and the access aisle (see above) or the access aisle and the accessible route to the accessible entrance? [ADA Standards § 4.6.6]

Yes

No

If No, is there another area with a curb ramp and on an accessible route that could serve as the drop-off area?

If there is no curb ramp near the drop-off area, can a temporary ramp be used to connect the drop-off area access aisle to the accessible route to the accessible shelter entrance?

A6. If a curb ramp is provided, is the running slope of the ramp surface (not counting the side flares) no more than 1:12 or 8.33% [ADA Standards § 4.7.2]

Yes

No

A7. Is the width of the curb ramp surface at least 36 inches (not counting the side flares)? [ADA Standards § 4.7.3]

Yes

No

A8. Does an accessible route connect the curb ramp to the shelter's accessible entrance? [ADA Standards § 4.1.2(1)]

Yes No

B. Parking

1. Typical Issues

During an evacuation, some individuals with a mobility disability may arrive at the shelter in a car or van. When parking areas are provided at the shelter site, accessible parking spaces must be provided. Individuals with disabilities who arrive at the shelter in their own car or van need to be able to park in an accessible parking space close to an accessible entrance. Accessible parking spaces need an adjacent access aisle that provides space for a person with a mobility disability to exit their vehicle. The access aisle connects directly to an accessible route that leads to an accessible building entrance. In order to be usable, the access aisle must be relatively level, clear of gravel or mud, and the surface must be in good condition without wide cracks or broken pavement.

An accessible route connects the permanent access aisle of each accessible parking space with the accessible entrance to the shelter. When an accessible route crosses a curb, a curb ramp must be provided. During an emergency, as a temporary measure, if additional accessible parking spaces are needed, a portable ramp can be provided in a parking space marked off by traffic cones to provide two additional accessible parking spaces (see page 18).

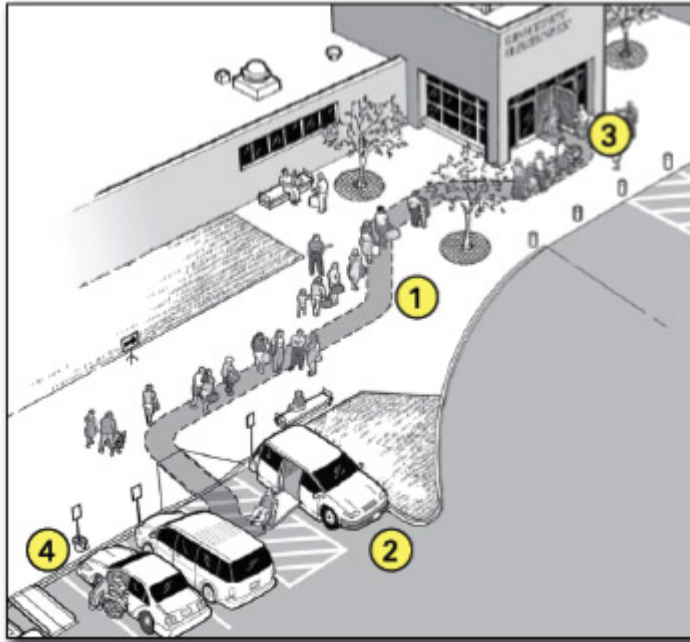

An accessible entrance to an emergency shelter with accessible parking and additional temporary accessible parking spaces

Notes:

1. Accessible route.
2. Accessible parking with van accessible parking space.
3. Accessible entrance to shelter.
4. Temporary accessible parking spaces.

2. Parking Spaces Checklist

B1. When parking areas are provided at the shelter site, count the total number of parking spaces provided in each area. Is the minimum number of accessible parking spaces provided, based on the total number of available parking spaces (see table below)? [ADA Standards § 4.1.2(5)(a)]

Yes

No

Total Number of Parking Spaces in Each Parking Area

Required Minimum Number of Accessible Spaces

1 - 25

1 van-accessible space w/min. 96-inch-wide access aisle (van space)

26 - 50

1 space w/min. 60-inch-wide access aisle +
1 van space

51 - 75

2 spaces w/min. 60-inch-wide access aisle +
1 van space

76 - 100

3 spaces w/min. 60-inch-wide access aisle +
1 van space

101 - 150

4 spaces w/min. 60-inch-wide access aisle +

1 van space

If more than 150 parking spaces are provided in a particular lot, see section 4.1.2 of the ADA Standards for the number of accessible parking spaces required.

B2. Does each accessible parking space have its own, or share, an adjacent access aisle that is least 60 inches (5 feet) wide? [ADA Standards § 4.6.3]

Yes

No

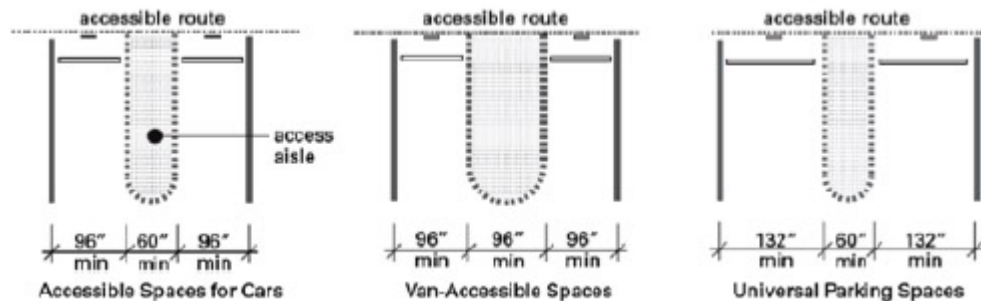

Accessible Parking Spaces Showing Minimum Width of Vehicle Space and Access Aisle

B3. Is there at least one van-accessible parking space provided with an access aisle that is at least 96 inches (8 feet) wide or are universal parking spaces provided that are 132 inches (11 feet) wide for vehicle space with a 60-inch (5-foot) wide access aisle? [ADA Standards § 4.1.2(5), A4.6]

Yes

No

B4. For van-accessible spaces (particularly in a garage or parking structure), is there vertical clearance of at least 98 inches (8 feet - 2 inches) for the vehicle route to the parking space, the parking space, the access aisle, and along the vehicle route to the exit? [ADA Standards § 4.6.5]

Yes

No

If No: Can the route be cleared by removing or raising low objects, or can each van accessible parking space be relocated?

B5. Are all accessible parking spaces, including the access aisle, relatively level (1:50 or 2%) in all directions? [ADA Standards § 4.6.3]

Yes

No

If No: Look for a nearby area that is relatively level in all directions that could serve as an accessible parking space with an accessible route to the accessible entrance to the shelter.

B6. Does each accessible parking space have a sign with the symbol of accessibility that is visible when a vehicle is parked in the space? [ADA Standards § 4.6.4]

Yes

No

B7. If there is a curb between the access aisle and the accessible route to the building, is there a curb ramp that meets the following requirements: [ADA Standards § 4.7]

Yes

No

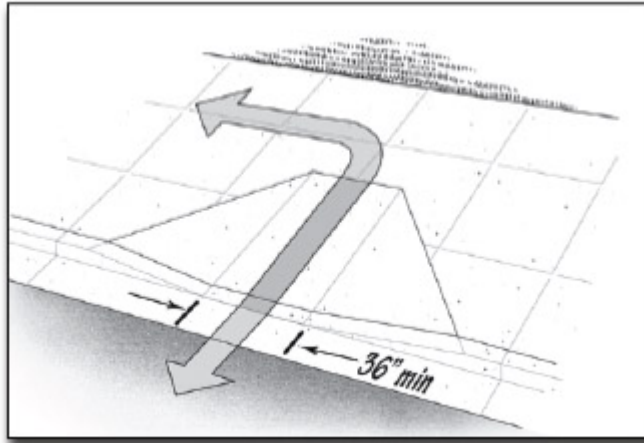

Curb ramp showing minimum 36-inch width for ramp section and 1:12 slope on ramp section.

B7-a. Is the curb ramp surface at least 36 inches wide, excluding flared sides? [ADA Standards § 4.7.3]

Yes

No

B7-b. Is the slope (up or down the ramp) no more than 1:12? [ADA Standards § 4.7.2]

Yes

No

Note: 1:12 is one inch of vertical height for each 12 inches of length.

B8. Are the accessible parking spaces serving the shelter on the shortest accessible route to the accessible entrance? [ADA Standards § 4.6.2]

Yes

No

B9. Does each access aisle connect to an accessible route from the parking area to the shelter's accessible entrance? [ADA Standards § 4.6.2]

Yes

No

3. Temporary Solutions for Emergency Sheltering - Parking

Problem: Parking at the shelter facility either has no accessible parking, not enough accessible parking, or accessible parking spaces are not on level ground.

Suggestion: Find a fairly level parking area near the accessible entrance and mark the area for accessible parking spaces. Three regular parking spaces will make two accessible parking spaces with a shared access aisle. Provide a sign designating each accessible parking space. Ensure there is an accessible route from each access aisle to the accessible entrance.

If temporary accessible spaces are used, mark the temporary accessible parking spaces with traffic cones or other temporary elements. Traffic cones can also be used to mark off an access aisle if designated accessible parking spaces lack an access aisle or if the access

aisle is too narrow. At least one accessible parking space should be a van-accessible parking space with an access aisle that is at least 96 inches wide.

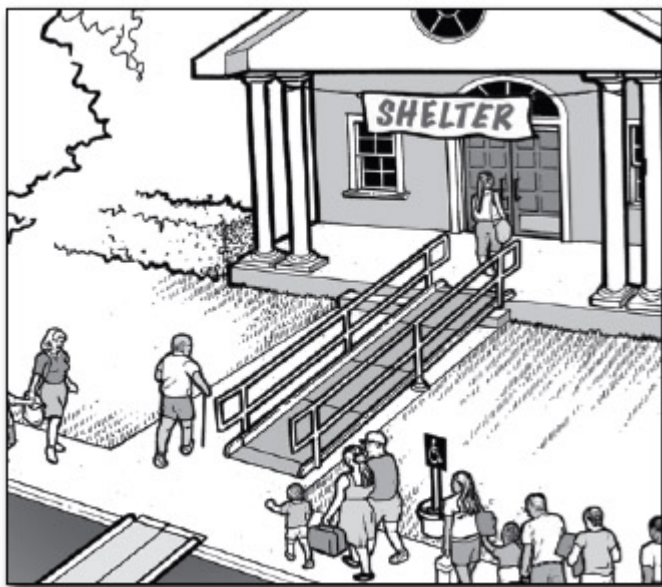

Three standard parking spaces are converted into an accessible parking space with an access aisle. Cones mark the access aisle and a temporary curb ramp with edge protection connects to an accessible route to the shelter.

C. Sidewalks and Walkways

1. Typical Issues for Individuals Who Use Wheelchairs, Scooters, or other Mobility Devices

An accessible route connects accessible passenger drop-off areas, accessible parking spaces, and other accessible elements, like a route from a bus stop, to an accessible building entrance. The accessible route is essential for people who have difficulty walking or who use wheelchairs or other mobility aids to get to the accessible entrance of the shelter. The accessible route must be at least 36 inches wide (it may narrow briefly to 32 inches wide where utility poles, signs, etc. are located along the accessible route). Abrupt level changes, steps, or steep running or cross slopes cannot be part of an accessible route. Where ramps are used, they cannot be steeper than 1:12. Ramps with a vertical rise of more than 6 inches must have handrails on both sides. Ramps must also have edge protection to stop

wheelchairs from falling off the sides, and level landings at the top and bottom of each segment and where the ramp changes direction.

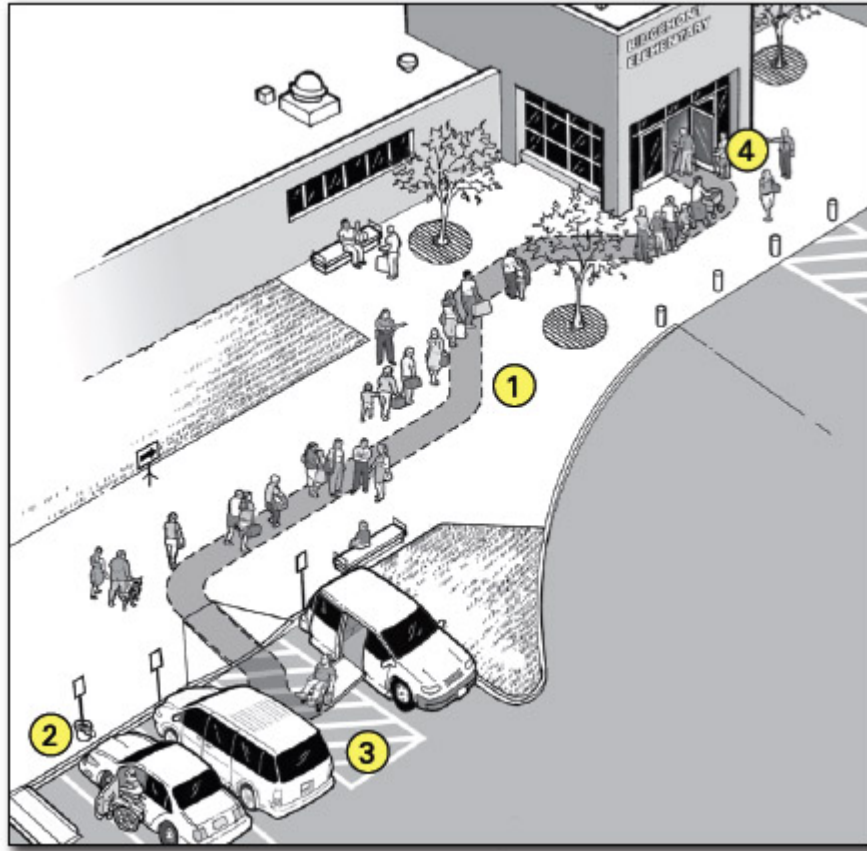

An accessible entrance to a shelter with accessible parking and an accessible drop-off area

Notes:

1. Accessible route
2. Accessible drop-off area

3. Accessible parking with van-accessible parking space

4. Accessible entrance to shelter

C1-a. Is an accessible route provided from accessible parking spaces to the accessible entrance of the shelter? [ADA Standards § 4.1.2(1), 4.3]

Yes

No

C1-b. Is an accessible route provided from public sidewalks and public transportation stops on the shelter site (if provided) to the accessible entrance for the shelter? [ADA Standards § 4.1.2(1)]

Yes

No

Note: The accessible route is at least 36 inches wide and may be a portion of a sidewalk.

C1-c. Is the accessible route at least 36 inches wide? [ADA Standards § 4.3.3]

Yes

No

If No, does the accessible route narrow to 32 inches for no more than 2 feet?

C1-d. Is the accessible route free of steps and abrupt level changes higher than 1/2 inch? [ADA Standards § 4.3.8]

Yes

No

Note: Level changes between 1/4 inch and 1/2 inch should be beveled (sloped) at 1:2 maximum.

C1-e. Where an accessible route crosses a curb, is a curb ramp provided? [ADA Standards § 4.3.8]

Yes

No

e-i. Is the curb ramp surface at least 36 inches wide, excluding flared sides? [ADA Standards § 4.7.3]

Yes

No

e-ii. Is the running slope (up or down the ramp) no more than 1:12? [ADA Standards § 4.7.2]

Yes

No

Note: 1:12 is one inch of vertical height for 12 inches of horizontal distance.

C1-f. If the slope of part of the accessible route is more than 1:20, does it meet the following requirements for an accessible ramp?

Yes

No

f-i. Is the running slope no greater than 1:12? [ADA Standards § 4.8.2]

Yes

No

Note: For existing ramps, the slope may be 1:10 for a 6-inch rise and 1:8 for a 3-inch rise in special circumstances (see ADA Standards § 4.1.6(3)).

f-ii. Are handrails installed on both sides of each ramp segment? [ADA Standards § 4.8.5]

Yes

No

f-iii. Is the ramp width, measured between the handrails, at least 36 inches? [ADA Standards § 4.8.3]

Yes

No

f-iv. Does the ramp have a level landing at the top and bottom of each ramp section that is at least 60 inches long? [ADA Standards § 4.8.4]

Yes

No

Note: The level landing may be part of the sidewalk or walking surface.

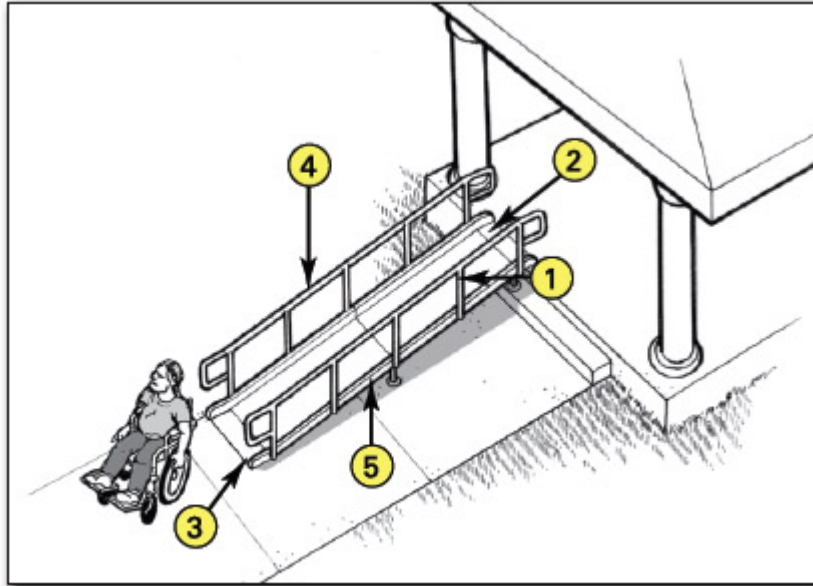

Accessible ramp features

Notes:

1. At least 36 inches between handrails

2. Top landing part of walk
3. Bottom landing part of walk
4. Handrail height 34 to 38 inches
5. Edge protection.

f-v. If a ramp is more than 30 feet long, is a level landing at least 60 inches long provided at every 30 feet of horizontal length? [ADA Standards § 4.8.4]

Yes

No

Note: if the running slope is less than 1:16 but more than 1:20, each ramp segment may be up to 40 feet long followed by a level landing].

f-vi. Is there a level landing, at least 60 inches x 60 inches, when a ramp changes direction? [ADA Standards § 4.8.4]

Yes

No

f-vii. Are the handrails mounted 34 to 38 inches above the ramp surface? [ADA Standards § 4.8.5]

Yes No

f-viii. If the ramp or landing has a vertical drop-off on either side, is edge protection provided? [ADA Standards § 4.8.7]

 Yes No

Temporary Solutions For Emergency Sheltering - Ramps

Problem: The sidewalk connecting parking to the shelter entrance is too steep to be accessible.

Suggestion: Check to see if there is another accessible route to the accessible entrance. Sometimes there is a less direct route that is accessible. During an evacuation it will be helpful to put up signs or to have volunteers stationed at the accessible parking spaces to direct people along this less direct, but nonetheless accessible, route.

Problem: The accessible route crosses a curb but no curb ramp is provided.

Suggestion: Install a portable ramp with a slope no steeper than 1:12 with edge protection. Store the portable ramp on site so it can be easily accessed in an emergency.

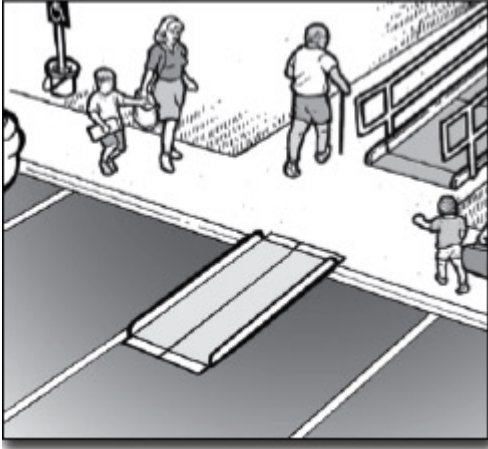

A portable ramp with edge protection is installed over a curb to provide an accessible route.

Problem: There are two steps where the sidewalk connects to the accessible entrance.

Suggestion: Install a portable ramp with a slope no steeper than 1:12 with edge protection and handrails on both sides of the ramp. Store the portable ramp and components on site so everything can be easily accessed in an emergency.

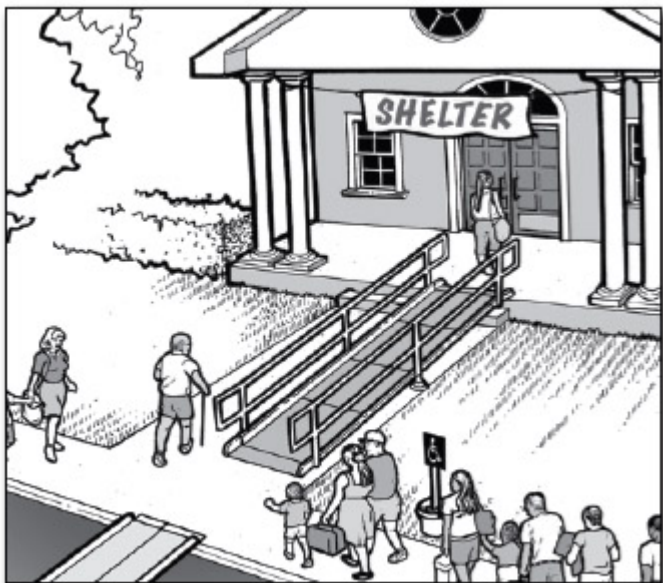

A portable ramp with edge protection and handrails is installed over two steps to provide an accessible route.

2. Typical Issues for Individuals Who Are Blind or Have Low Vision

Objects that are wall mounted, that project into a pedestrian route from the side, or that are overhead can be hazards to people who are blind or who have low vision. These objects must be positioned so people will either detect the objects before they run into them or safely pass under them. Examples may include handrail extensions on stairs and ramps, post- or wall-mounted signs, drinking fountains, and low hanging tree limbs. Pedestrian routes open to people during the time that the facility is being used as an emergency shelter, such as sidewalks, courtyards, and plazas, must be free of overhanging objects that are less than 80 inches above the route. Objects more than 27 inches and less than 80 inches above the route and that protrude from the side more than 4 inches are also a hazard. Since people can walk on any sidewalk, not just the accessible routes, all exterior pedestrian routes serving or leading to the shelter areas must be checked. The following questions apply to sidewalks and walkways leading to the emergency shelter.

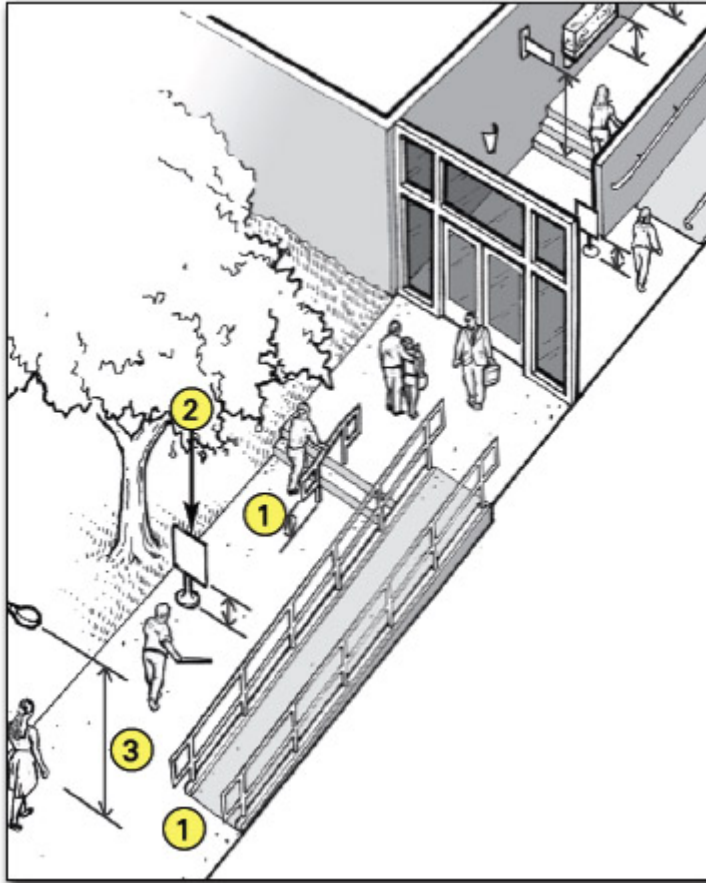

Common objects along pedestrian routes to a shelter that can be hazards to people who are blind or have low vision.

Notes:

1. The bottom of the handrail extensions turn down to 27 inches or less above the route so a person who is blind or has low vision can detect the hazard before running into it.

2. Signs or other objects in the pedestrian route can be a hazard if the bottom is more than 27 inches but less than 80 inches above the route.
3. Objects that overhang the pedestrian route must be at least 80 inches above the route.

C2-1. Are all sidewalks and walkways to the shelter free of any objects (e.g., wall-mounted boxes, signs, handrail extensions) with bottom edges that are between 27 inches and 80 inches above the walkway and that extend more than 4 inches into the sidewalk or walkway?

[ADA Standards §§ 4.4, 4.2.1(3), 4.1.3(2)]

Yes

No

If No, can the object be lowered, removed, or modified or can the route be moved so that the object can be avoided?

C2-2. Are the undersides of exterior stairs enclosed or protected with a cane-detectable barrier so that people who are blind or have low vision will not hit their heads on the underside? [ADA Standards § 4.4.2]

Yes

No

If No, can a barrier or enclosure be added below the stair or can the route be relocated away from the stair?



When the underside of a stair is open, it is a hazard to people who are blind or have low vision. Enclosing the area below the stair or installing a cane-detectable barrier helps this woman to stop before hitting her head.

C2-3. Are all objects that hang over the pedestrian routes at least 80 inches above the route? [ADA Standards § 4.4.2]

Yes

No

If No, can the objects be removed or relocated, or can a cane-detectable object be added below that is at no higher than 27 inches?

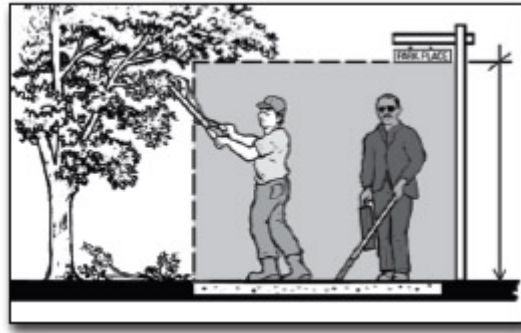

**Overhead sign and tree branches are least
80 inches above the walk.**

Temporary Solutions For Emergency Sheltering - Protruding Object Hazards

Problem: Objects protrude too far from the side into the route causing a hazard for people who are blind or who have low vision.

Suggestion: When people who are blind or who have low vision use a cane to detect hazards, objects located at 27 inches or lower are detectable. When an object is located higher than 27 inches above the ground it is a hazard if the object protrudes more than 4 inches into the circulation path. To make a protruding object cane-detectable:

- Place an object below, or on either side of, the protruding object that is not higher than 27 inches above the ground.
- If the protruding object can be moved, lower the object so that its bottom is not more than 27 inches above the ground.
- Prune or alter the protruding object so it does not protrude above the route.

A shelter must have at least one accessible entrance that is on an accessible route. An accessible entrance must provide at least one accessible door with maneuvering space, accessible hardware, and enough clear width to allow people who use crutches, a cane, walker, scooter, or wheelchair to use it.

If the accessible entrance is not the main entrance to the facility that is being used as a shelter, signs must be located at inaccessible entrances to direct evacuees and volunteers to the accessible entrance. The accessible entrance must be unlocked when other shelter entrances are unlocked.



Examples of signs for inaccessible shelter entrances directing people to the accessible entrance.

D1. Is there at least one accessible entrance connected to an accessible route? [ADA Standards § 4.1.3(1)]

Yes No

Notes: If this entrance is not the main entrance, it needs to be kept unlocked when other shelter entrances are unlocked.

If there are inaccessible entrances serving the shelter, signs will be needed at inaccessible entrance(s) to direct evacuees to the nearest accessible entrance.

D2. Does at least one door or one side of a double leaf-door provide at least 32 inches clear passage width when the door is open 90 degrees? [ADA Standards § 4.13.5]

 Yes No

If No, does another entrance have an accessible door or can both doors be propped open during the evacuation? Other possible solutions are to enlarge the door opening, use a swing clear hinge, or, if a double-leaf door, replace with uneven width doors.

D3. Is the hardware (e.g., lever, pull, and panic bar) usable with one hand without tight grasping, pinching, or twisting of the wrist? [ADA Standards § 4.13.9]

 Yes

No

If No, leave door propped open, add new accessible hardware, or adapt/replace hardware.

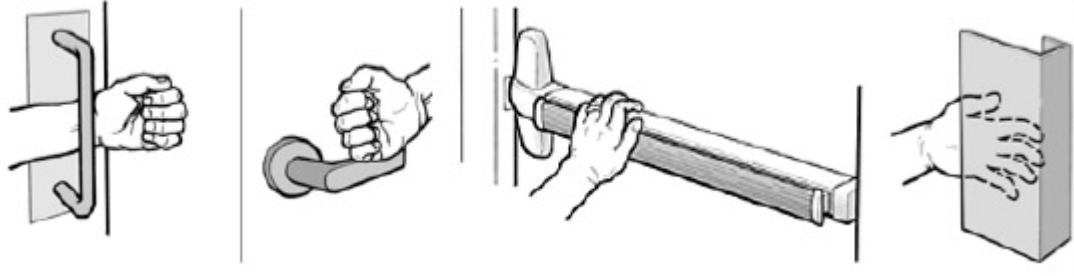

Examples of handles and door hardware that can be used without tight grasping, pinching, or twisting.

D4. On the latch, pull side of the door, is there at least 18 inches clearance provided if the door is not automatic or power-operated? [ADA Standards § 4.13.6, Fig. 25]

 Yes No

If No, leave the door propped open or find another accessible entrance.

D5. If there is a raised threshold, is it no higher than 3/4 inch at the door and beveled on both sides? [ADA Standards §§ 4.1.6(3)(d)(ii), 4.13.8]

Yes

No

If No, replace threshold with one with beveled sides or add a sloped insert.

D6. If an entry has a vestibule, is there a 30-inch by 48-inch clear floor space inside the vestibule where a wheelchair or scooter user can be outside the swing of a hinged door? [ADA Standards § 4.13.7]

Yes

No

If No, leave the inner door permanently open, remove inner door, or modify the vestibule.

E. Hallways and Corridors

1. Typical Issues for Individuals Who Use Wheelchairs, Scooters, or Other Mobility Devices

The interior accessible route connects the accessible entrance with the various service and activity areas within the shelter. Typically made up of hallways, corridors, and interior rooms and spaces, the accessible route is essential for people who have difficulty walking or who use wheelchairs or other mobility aids to get to all of the service and activity areas of the shelter.

An accessible route is at least 36 inches wide and may narrow briefly to 32 inches wide where the route passes through doors or next to furniture and building elements. High thresholds, abrupt level changes, steps, or steep running or cross slopes cannot be part of an accessible route. Where ramps are used, they cannot be steeper than 1:12. Ramps with a vertical rise of more than 6 inches must have

handrails on both sides. Ramps must also have edge protection to stop wheelchairs from falling off the sides, and level landings at the top and bottom of each segment and where a ramp changes direction.

Where an accessible route is different from the route used by most evacuees, signs will be needed at key decision points to direct individuals with disabilities to the various activity areas.

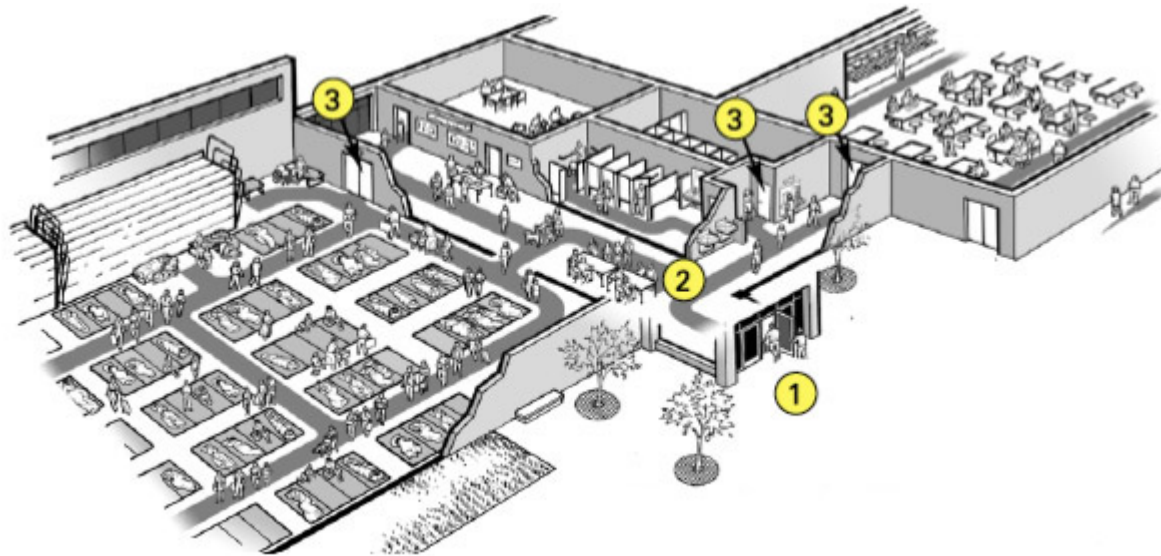

Interior of a shelter showing the accessible route from the accessible entrance to all service and activity areas.

Notes:

1. Accessible Entrance
2. Accessible Route connects the accessible entrance with shelter service and activity area
3. Accessible door to service and activity areas

E1-a. Is there an accessible route, at least 36 inches wide, that connects the accessible entrance to all shelter areas (it may narrow to 32 inches wide for up to 2 feet in length)? [ADA Standards § 4.3.2(3)]

Yes

No

E1-b. Is the accessible route free of steps and abrupt level changes over 1/2 inch?

Yes

No

Note: level changes between 1/4 inch and 1/2 inch should be beveled). [ADA Standards §§ 4.1.3(1), 4.3.8]

E1-c. Does the accessible route from the accessible entrance to all activity areas change levels using a ramp, lift or elevator? [ADA Standards §§ 4.1.3(1), 4.3.8]

Yes

No

If No, go to question E1-g.

c-i. If Yes, is a ramp or sloped hallway provided?

Yes

No

If Yes, go to question E1-d.

c-ii. Is an elevator or lift provided?

Yes

No

If Yes, and the elevator or lift is part of the accessible route to a shelter area, is back-up electrical power available to operate the elevator or lift for the duration of shelter operation should the normal electrical service be disrupted?

If Yes and an elevator is provided, see question E1-e.

If Yes and a lift is provided, see question E1-f.

If No, then either provide back-up electrical power to operate the lift or elevator during the power outage or locate shelter services exclusively on accessible levels that may be reached by people with a mobility disability without using an elevator or lift.

E1-d. Where the slope of the accessible route is greater than 1:20, does this area meet the following requirements for an accessible ramp?

Yes

No

d-i. Is the slope no greater than 1:12? [ADA Standards § 4.8.2]

Yes

No

Note: For existing ramps, the slope may be 1:10 for a 6-inch rise and 1:8 for a 3-inch rise in special circumstances]. [ADA Standards § 4.1.6(3)]

d-ii. Are handrails installed on both sides of each ramp segment? [ADA Standards § 4.8.5]

Yes

No

d-iii. Is the ramp width, measured between handrails, at least 36 inches? [ADA Standards § 4.8.3]

Yes

No

d-iv. Are the handrails mounted 34 to 38 inches above the ramp surface? [ADA Standards § 4.8.5]

Yes No

d-v. If a ramp is longer than 30 feet, is a level landing at least 60 inches long provided every 30 feet? [ADA Standards § 4.8.4]

 Yes No

d-vi. Does the ramp have a level landing that is at least 60 inches long at the top and bottom of each ramp section or where the ramp changes direction? [ADA Standards § 4.8.4]

 Yes No

d-vii. If the ramp or landing has a vertical drop-off on either side of the ramp, is edge protection provided? [ADA Standards § 4.8.7]

 Yes No

E1-e. Is an elevator provided to each of the levels on which each sheltering service or activity area is located?

Yes No

e-i. Are the centerlines of the call buttons mounted 42 inches above the floor? [ADA Standards § 4.10.3]

 Yes No

e-ii. Does the floor area of the elevator car have space to enter, reach the controls, and exit? [ADA Standards § 4.10.9, Fig. 22]

 Yes No

Fig. 22
Minimum Dimensions of Elevator Cars

Note: See Figure 22 for acceptable floor and opening dimensions. Floor dimensions of at least 48 inches by 48 inches may be allowed in existing facilities built before the ADA went into effect.

e-iii. Can the elevator be called and operated automatically without using a special key or having to turn on the elevator from a remote location? [ADA Standards § 4.10.2]

Yes

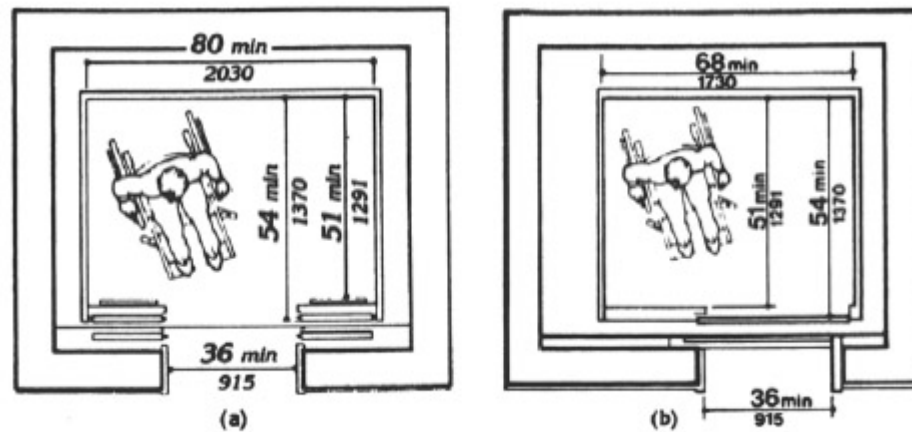
No

e-iv. Are the highest floor control buttons mounted no more than 54 inches above the floor for a side reach or 48 inches for forward reach? [ADA Standards § 4.10.12 (3)]

Yes

No

e-v. Are raised letters and Braille characters used to identify each floor button and each control? [ADA Standards § 4.10.12]

Yes

No

e-vi. Are signs mounted on both sides of the elevator hoist way door opening (for each elevator and at each floor) that designate the floor with 2-inch minimum-height raised letters and Braille characters centered at 60 inches above the floor?

[ADA Standards § 4.10.5]

Yes

No

e-vii. Is the elevator equipped with audible tones or bells or verbal annunciators that announce each floor as it is passed?

[ADA Standards § 4.10.13]

Yes

No

E1-f. If a wheelchair lift is provided, does it meet the following?

Yes

No

f-i. Is the lift operational at the time of the survey? [ADA Standards § 4.11.3]

Yes

No

f-ii. Is the change in level from the floor to the lift surface ramped or beveled? [ADA Standards §§ 4.11.2, 4.5.2]

Yes No

f-iii. Is there at least a 30-inch by 48-inch clear floor space on the wheelchair lift? [ADA Standards §§ 4.11.2, 4.2.4]

 Yes No

f-iv. Does the lift allow a person using a mobility device unassisted entry, operation (is key available, if required), and exit?

 Yes No

f-v. Are the controls and operating mechanisms mounted no more than 54 inches above the floor for a side reach or 48 inches for a forward reach? [ADA Standards §§ 4.11.2, 4.27.3]

 Yes No

f-vi. Are the controls and operating mechanisms usable with one hand without tight grasping, pinching, or twisting? [ADA Standards §§ 4.11.2, 4.27.4]

Yes No

E1-g. At each location on the way to each shelter activity area where the accessible route passes through a door, does at least one door meet the following requirements?

 Yes No

g-i. Is the clear width for the door opening at least 32 inches measured when the door is open 90 degrees? [ADA Standards §§ 4.1.3(7), 4.13.5]

 Yes No

g-ii. Is the door hardware (e.g., lever, pull, push, panic bar) usable with one hand, without tight grasping, pinching, or twisting of the wrist, to allow people who may not be able to easily use one or both hands to fully operate the hardware? [ADA Standards § 4.13.9]

 Yes No

g-iii. Is there clear maneuvering floor space in front of each accessible door (see ADA Standards § Fig. 25) and, on the pull side, is there at least 18 inches clear floor space beyond the latch side of the door (see space configurations in Figure 25)?

[ADA Standards § 4.13.6]

Yes

No

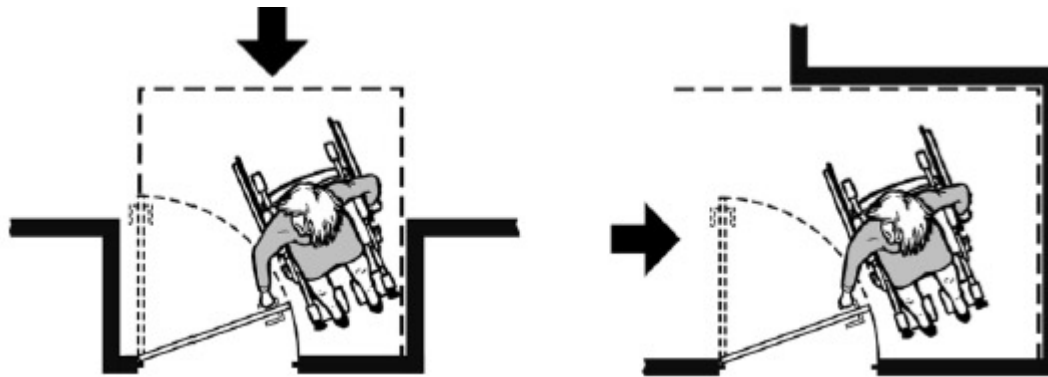

A clear floor space on the latch side of the door (pull side) allows a person using a wheelchair or scooter to pull the door open and then enter. The size of the clear floor space varies depending on the direction of approach (shown by the arrows) and the door swing.

g-iv. Is no more than 5 pounds force needed to push or pull open the door? [ADA Standards § 4.13.11 (2)(b)]

Yes

No

Note: Fire doors are still considered to be accessible if they have the minimum opening force allowable by the appropriate administrative authority.

g-v. If the answers to questions g-ii thru g-iv are No, can the door be propped open?

Yes

No

If an activity area is not on an accessible route and cannot be made accessible, find another area that is on an accessible route where that activity may be provided.

2. Typical Issues for People Who are Blind or Have Low Vision

Individuals who are blind or have low vision may walk along any route or through any shelter activity area, not just the accessible routes. That means any area where people using the shelter can walk, including hallways, corridors, eating areas, and sleeping areas, must be free of objects that cannot be detected by a person who is blind or has low vision. Objects that are wall mounted, that project into a pedestrian route from the side, or that are overhead must be located so that individuals who are blind or have low vision will either detect the objects before they run into them or safely pass under them. These routes must be free of overhanging objects that are less than 80 inches above the floor and side objects that protrude into the route more than 4 inches when the bottom of the object is more than 27 inches above the floor. Items to watch for include wall-mounted fire extinguishers and wall-mounted display cases when the bottom is more than 27 inches above the floor, wall sconces and light fixtures that protrude more than 4 inches off the wall, and open staircases, exit signs, overhead signs, banners, and arched doorways that are lower than 80 inches above the floor.



Overhead and wall-mounted objects that may be hazards along a pedestrian route

Notes:

1. Wall-mounted drinking fountains are a hazard when the front projects more than 4 inches beyond the wall and the bottom is more than 27 inches above the floor.
2. Wall-mounted objects cannot project more than 4 inches beyond the wall if the bottom is not in the cane-detectable area below 27 inches off the floor.

3. Overhead objects must be at least 80 inches off the floor.

The following questions apply to pedestrian routes serving or leading to the shelter activity and common use areas.

E2-a. Are pedestrian routes leading to or serving each service or activity area of the shelter free of objects that protrude from the side more than 4 inches into the route with the bottom of the object more than 27 inches above the floor? [ADA Standards § 4.4.1]

Yes

No

Note: These objects may be wall mounted or free standing. Items to check include wall-mounted fire extinguishers, light fixtures, coat hooks, shelves, drinking fountains, and display cases.

E2-b. Are pedestrian routes leading to or serving each of the service or activity areas free of overhead objects with the bottom edge lower than 80 inches above the floor? [ADA Standards § 4.4.2]

Yes

No

E2-c. Are any interior stairs along these routes configured with a cane-detectable warning or a barrier that prevents travel into the area with less than an 80-inch high head clearance so that people who are blind or who have low vision cannot hit their heads on the underside or stair frame? [ADA Standards § 4.4.2]

Yes No

If No, list the objects that are a hazard and their location. Remove or relocate the object or place a detectable object on the floor below each object to remove the hazard.



When the underside of a stair is open, it is a hazard to people who are blind or have low vision. Enclosing the area below the stair or installing a cane

**detectable barrier helps the person to
avoid the area.**

F. Check-In Areas

A shelter usually has one or more check-in areas located near the entrance to the shelter. When check-in areas are provided, then at least one accessible check-in location should be provided. The accessible check-in area should be at the accessible entrance or signs should give directions to the accessible check-in area.

If a permanent reception counter is used for check in, make sure to provide a writing surface at an accessible height for people who use a wheelchair, scooter, or other mobility device. This may be a part of the reception counter that is no higher than 36 inches above the floor, a folding shelf or an adjacent table, or a clip board.



**An accessible check-in location using a folding table
with a height that people who use wheelchairs can
easily reach.**

F1. Is there an accessible route that connects the accessible entrance to areas that are likely to be used to register people as they arrive at the shelter? [ADA Standards § 4.3]

Yes

No

F2. If there is a built-in reception or other type of counter, does it have a section that is at least three feet long that is no higher than 36 inches above the floor or is there a nearby surface that is not higher than 36 inches above the floor? [ADA Standards § 7.2]

Yes

No

Living at the Emergency Shelter

G. Sleeping Areas

Each accessible sleeping area needs to be on an accessible route connecting it to other activity areas in the shelter, including toilet rooms and bathing areas. An accessible route with adequate circulation and maneuvering space provides access in the sleeping areas for people who use wheelchairs or scooters and this route serves each accessible bed or cot.

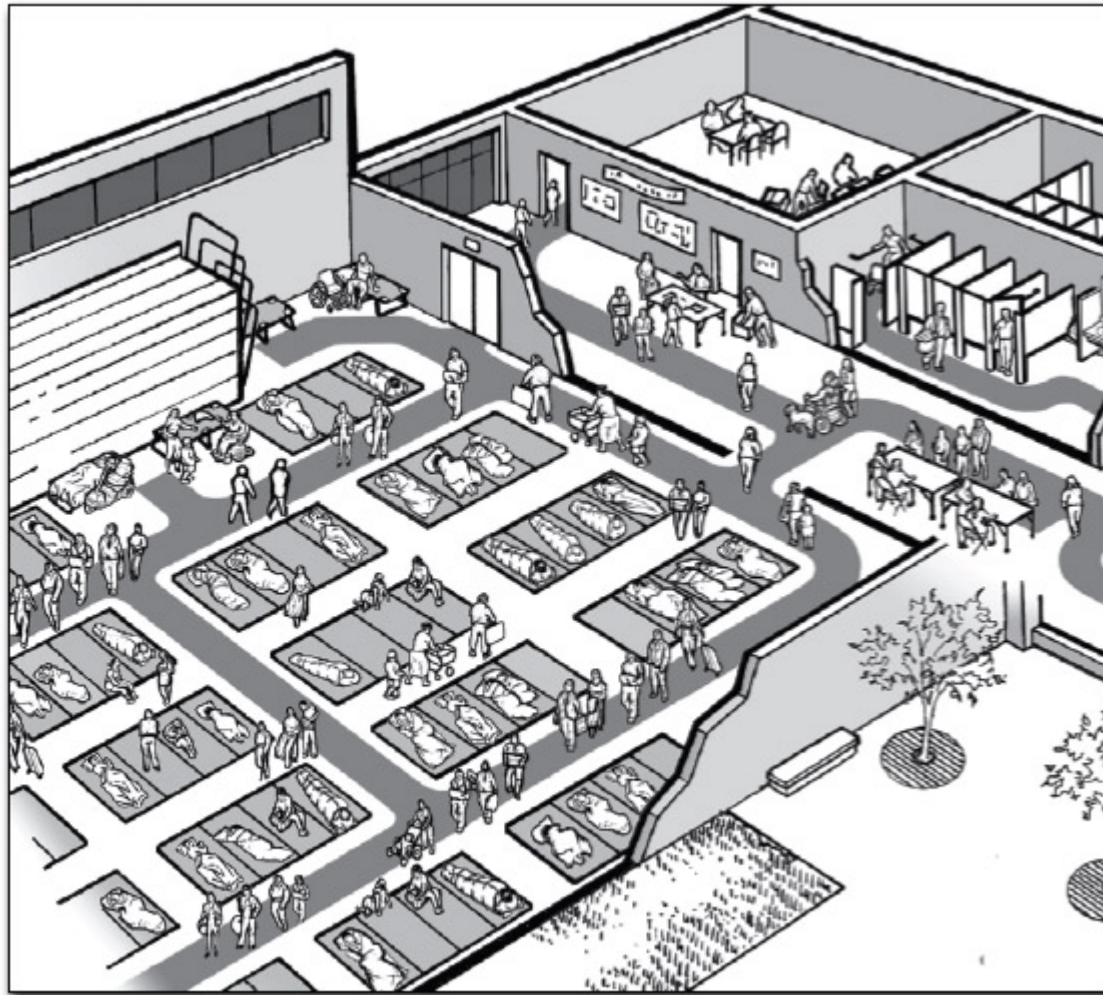

Interior of one section of a shelter's sleeping area. The shaded pathway indicates the accessible route, which provides access to accessible beds, cots, and other activity areas in the space plus the toilet rooms and other activity areas in the shelter.

Accessible cots have a sleeping surface at approximately the same height above the floor as the seat of a wheelchair (17 to 19 inches above the floor). When placed in several sections of the sleeping area, individuals who use a wheelchair, scooter, or other mobility device will be able to sleep near their family or other companions. An accessible route is needed to provide access to each accessible cot and a clear space at least 36 inches wide is needed along the side of the cot to make it possible to transfer between the mobility

device and the cot. A preferred location for accessible cots is to have one side against a wall. This helps to stabilize the cot and the wall can act as a backrest when the person sits up on the cot.

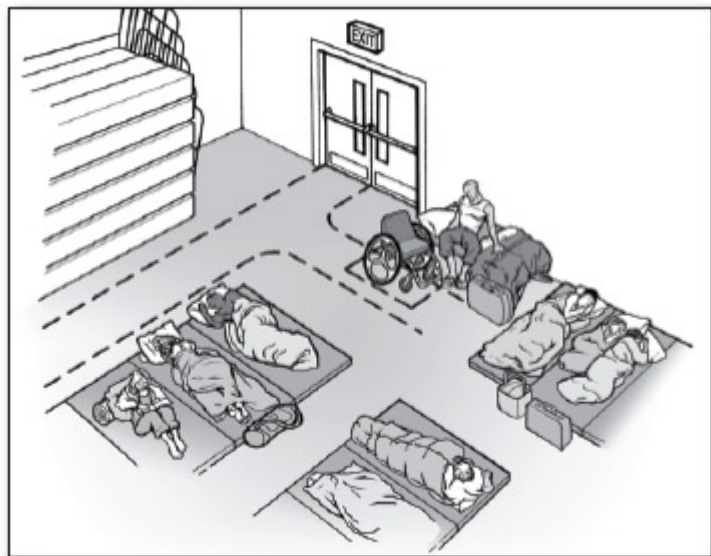

An accessible cot positioned against a wall. Dashed lines indicate the accessible route and clear floor space next to the cot.

G1. Is there an accessible route, at least 36 inches wide, that connects each sleeping area with other shelter activity areas?

Yes

No

Note: it may narrow to 32 inches wide for up to 2 feet in length. [ADA Standards § 4.3.2(3)]

G2. Is the accessible route free of steps and abrupt level changes over 1/2 inch?

Yes

No

Note: level changes between 1/4 inch and 1/2 inch should be beveled). [ADA Standards §§ 4.1.3(1), 4.3.8]

Note: Although the facility survey cannot check the accessibility of the cots because they will not be installed until the shelter is in use, planning for setting up the sleeping area and for arranging the cots and mats should include providing space for an accessible route and clear floor space at each accessible cot. Cots used by people who are blind or who have low vision should be in an easily locatable area.

H. Restrooms and Showers

At least one set of toilet rooms serving the shelter must be accessible to individuals who use a wheelchair, scooter, or other mobility device. In large shelters where more than one set of toilet rooms is needed to serve the occupants, it may be necessary to provide additional accessible toilet facilities or to establish policies to assure that individuals with disabilities have access to the accessible facilities.

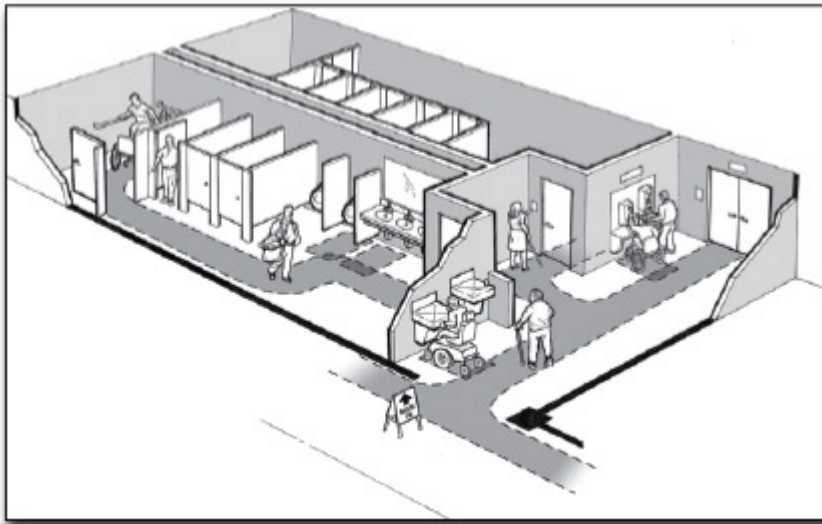

Interior of an accessible toilet room showing accessible route, clear floor space at accessible fixtures, and the wide accessible toilet stall.

H1. If a sign is provided at the toilet room entrance (e.g. Men, Women, Boys, Girls, etc.), is a sign with raised characters and Braille mounted on the wall adjacent to the latch? [ADA Standards § 4.30.6]

Yes

No

If No, install a sign with raised characters and Braille on the wall adjacent to the latch side of the door and centered 60 inches above the floor and leave the existing sign in place on the door if removing it will damage the door.

Note: an additional sign may be mounted on the toilet room door but this cannot be considered to be the accessible sign which must be mounted on the wall adjacent to the latch side of the door.

H2. Does the door to the toilet room provide at least 32 inches clear passage width when the door is open 90 degrees? [ADA Standards § 4.13.5]

Yes

No

H3. Is the hardware (e.g., lever, pull, panic bar) usable with one hand without tight grasping, pinching, or twisting of the wrist? [ADA Standards § 4.13.9]

Yes

No

If No, can the door be propped open without compromising privacy, or can the hardware be modified by adding new accessible hardware, or adapting or replacing hardware?

H4. On the pull side of the door, is there at least 18 inches clearance provided on the latch side if the door is not automatic or power-operated? [ADA Standards § 4.13.6, Fig. 25]

Yes

No

H5. If there is a raised threshold, is it no higher than 3/4 inch at the door and beveled on both sides? [ADA Standards §§ 4.1.6(3)(d)(ii), 4.13.8]

Yes

No

NA

If No, replace threshold with one with beveled sides or add a sloped insert.

H6. If the entry has a vestibule, is there a 30-inch by 48-inch clear floor space inside the vestibule where a wheelchair or scooter user can be outside the door swing? [ADA Standards § 4.13.7]

Yes

No

If No, possible solutions include leaving the inner door open or removing the outer door.

H7. Inside the toilet room, is there an area where a person who uses a wheelchair or other mobility device can turn around - either at least 60-inch diameter circle or a "T"-shaped turn area as shown in the figures below? [ADA Standards §§ 4.22.3; 4.2.3]

Yes

No

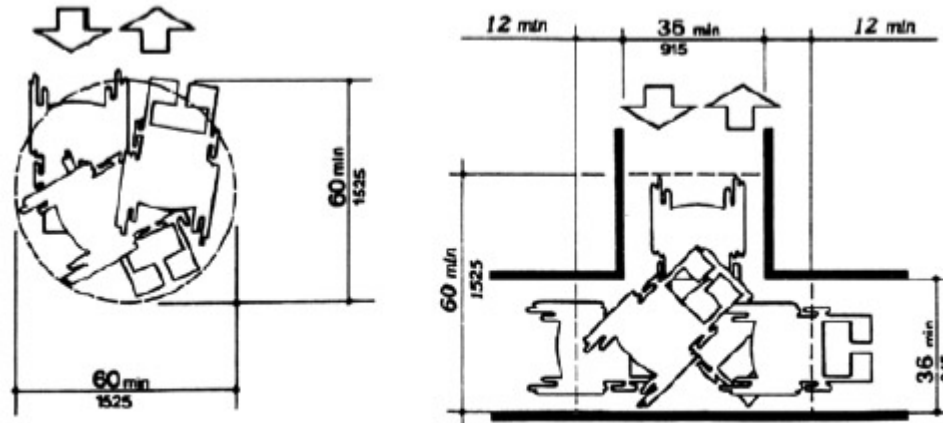

Minimum spaces for turning

Minimum spaces for turning

H8. If lavatories are provided, does at least one have at least a 29 inch high clearance under the front apron with the top of the rim no more than 34 inches above the floor? [ADA Standards § 4.19.2]

Yes

No

H9. Are the drain and hot water pipes for this lavatory insulated or otherwise configured to protect against contact? [ADA Standards § 4.19.4]

Yes

No

H10. Does this lavatory have controls that operate easily with one hand, without tight grasping, pinching, or twisting of the wrist? [ADA Standards § 4.19.5]

Yes

No

H11. If mirrors are provided, is the bottom of the reflecting surface for the mirror at this lavatory no higher than 40 inches above the floor or is a full length mirror provided? [ADA Standards § 4.19.6]

 Yes No

H12. For at least one of each type of dispenser, receptacle, or equipment, is there clear floor space at least 30 inches wide x 48 inches long adjacent to the control or dispenser (positioned either parallel to the control or dispenser or in front of it)? [ADA Standards §§ 4.23.7; 4.27.2; 4.2.5 and Fig 5; 4.2.6 and Fig 6]

 Yes No

H13. Is the operating control (switch, lever, button, or pull) of at least one of each type of dispenser or built-in equipment no higher than 54 inches above the floor (if there is clear floor space for a parallel approach) or 48 inches (if there is clear floor space for a front approach)? [ADA Standards §§ 4.23.7; 4.27.3; 4.2.5 and Fig 5; 4.2.6 and Fig 6]

 Yes No

H14. Are all built-in dispensers, receptacles, or equipment mounted so the front does not extend more than 4 inches from the wall if the bottom edge is between 27 inches and 80 inches above the floor? [ADA Standards §§ 4.23.7; 4.27; 4.4.1; Fig. 8]

 Yes No

Toilet Stalls

H15. Is at least one wide toilet stall provided with an out swinging door, side and rear grab bars, and clear space next to the toilet? [ADA Standards § 4.17]

Yes No

If No, check to see if another toilet room provides a wide accessible toilet stall, note its location for shelter planners, and answer all toilet room questions with respect to that toilet room.

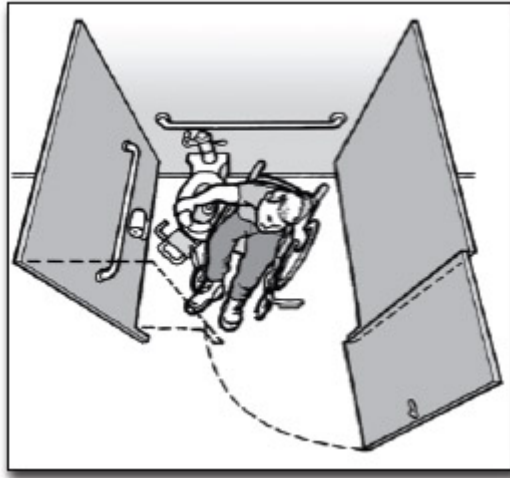

Overhead view of an individual using a wheelchair positioned beside a toilet in a wide accessible stall.

H16. Is the toilet stall at least 60 inches wide and 56 inches deep (wall mounted toilet) or 59 inches deep (floor mounted toilet)? [ADA Standards § 4.17.3]

 Yes No

If No, note the width and depth of the stall. _____

H17. Is at least 9 inches of toe clearance provided under the front wall and at least one side wall of the toilet stall? [ADA Standards § 4.17.4]

Yes No

H18. Is the centerline of the toilet 18 inches from the adjacent side wall? [ADA Standards § 4.16.2; 4.17.3]

 Yes No

H19. Is the top of the toilet seat 17 inches to 19 inches above the floor? [ADA Standards § 4.16.3]

 Yes No

H20. Is the flush valve located on the wide side adjacent to the lavatory or is an automatic flush valve provided? [ADA Standards § 4.16.5]

 Yes No

H21. Is a horizontal grab bar at least 40 inches long securely mounted on the adjacent side wall 33 to 36 inches above the floor with one end no more than 12 inches from the back wall 33 to 36 inches above the floor? [ADA Standards § 4.16.4; 4.17.6]

 Yes No

H22. Is a second horizontal grab bar at least 36 inches long securely mounted on the back wall with one end no more than 6 inches from the side wall 33 to 36 inches above the floor? [ADA Standards § 4.16.4; 4.17.6]

 Yes No

H23. Is the door to the toilet stall located diagonally opposite, not directly in front of, the toilet or on the opposite side wall from the wall with the long grab bar? [ADA Standards § 4.17.3]

Yes

No

H24. Unless the wide stall is located at the end of a row of toilet stalls, does the door to this wider stall open out? [ADA Standards § 4.17.3]

Yes

No

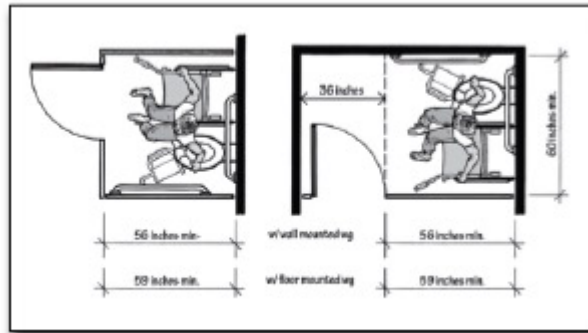

Plan views showing minimum sizes of wide accessible toilet stall

H25. Is the clear width of the door at least 32 inches (measured between the face of the door and the edge of the opening) when the door is open 90 degrees? [ADA Standards § 4.13.5]

Yes

No

H26. If there are 6 or more stalls in the restroom, is one of those stalls (in addition to the wider stall noted above) exactly 36 inches wide with an out swinging stall door that provides at least 32 inches of clear width? [ADA Standards § 4.22.4]

Yes No

H27. Does this 36-inch wide stall have horizontal grab bars on both of the side partitions that are at least 36 inches long and 33 to 36 inches above the floor? [ADA Standards § 4.22.4]

 Yes No

H28. Is the surface of the toilet seat in this 36-inch-wide stall 17 to 19 inches above the floor? [ADA Standards §§ 4.16.3; 4.22.4]

 Yes No

H29. If a coat hook is provided is it mounted no higher than 54 inches above the floor for a side approach or 48 inches above the floor for a front approach? [ADA Standards § 4.25.3]

 Yes No

Note: For many emergency shelters, evacuees are not expected to use shower or bathing facilities due to the short period they may stay at the shelter. If planning for the shelter operation includes offering shower or bathing facilities, then those facilities should be on an accessible route and checked for accessibility. For information on the requirements for accessible showers or bathtubs see the ADA Standards for Accessible Design which is available online at www.ada.gov.

The following are figures illustrating some accessible shower features from the ADA Standards.

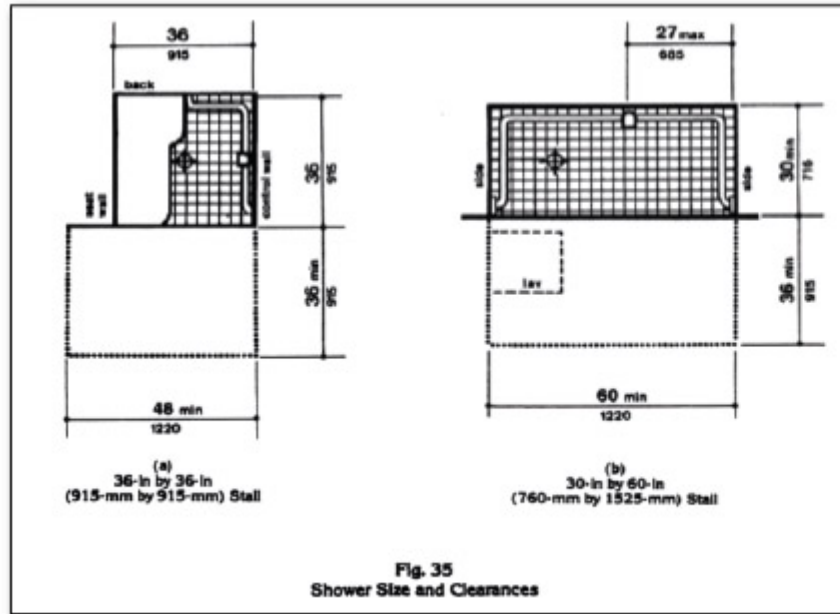

**Accessible Shower Stall
Minimum Size and Clearances**

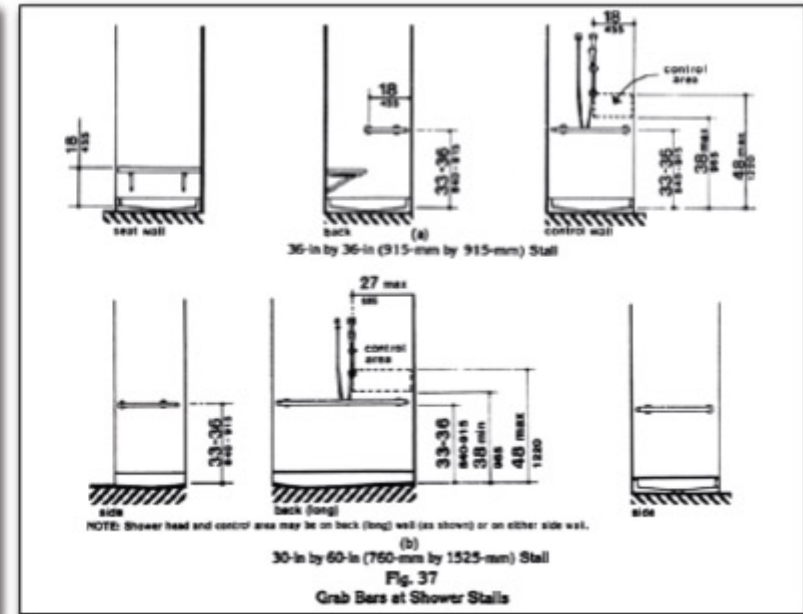

**Accessible Shower Stall Grab Bars
and Seat, Shower, and Control Area**

I. Public Telephones

When public telephones are provided, then one or more accessible public telephones should be provided in areas serving shelter activity and service areas. Whenever accessible telephones are provided, each should be on an accessible route. In shelters it is common to provide additional telephones on tables or desks and some of these telephones should be accessible.

A text telephone (also commonly known as a TTY) is a device that allows individuals who are deaf or hard of hearing or who have a speech disability to communicate over a telephone. Having at least one TTY in any building that has at least four pay phones, provides access for people who are deaf or hard of hearing.

11. If at least one public telephone or one bank of telephones is provided, does at least one of each type of telephone (e.g., pay telephone, intercom telephone, other telephone) have the following?

Yes

No

11a. For a side approach (clear floor space at least 30 inches long x 48 inches wide), is the coin slot no higher than 54 inches above the floor? [ADA Standards § 4.31.2, Fig. 44 (a)]

 Yes No

11b. For a front approach (where clear floor space at least 30 inches wide x 48 inches long), is the coin slot no higher than 48 inches above the floor? [ADA Standards § 4.31.2, Fig. 44 (b)]

 Yes No

12. Does the phone have volume controls? [ADA Standards § 4.31.5]

 Yes No

13. If three or more telephones are located in one bank serving the shelter, are a shelf and an electrical outlet provided at one telephone for use of a portable TTY? [ADA Standards § 4.31.9 (2)]

 Yes No

14. If four or more pay telephones are provided on the site, is there a TTY (text telephone) provided at the shelter?

 Yes No

If yes, location _____

15. Is there a sign at each pay phone or pay phone bank for the shelter directing people to the nearest TTY? [ADA Standards § 4.30.7 (3); 4.31.9(3)]

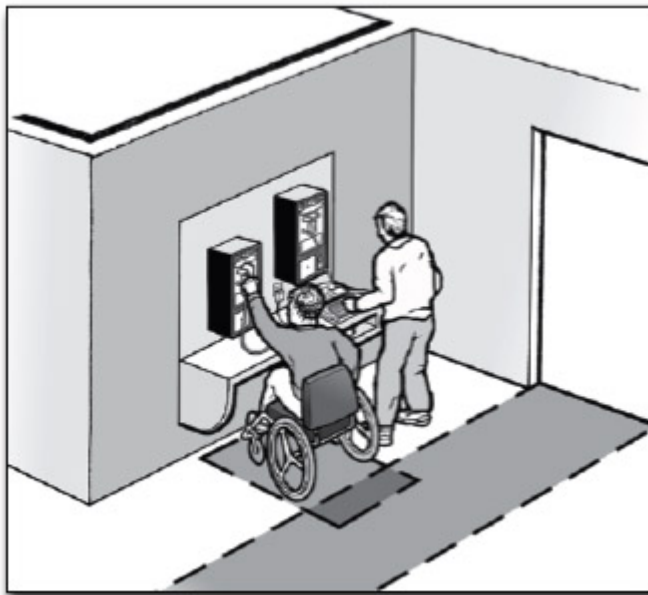
Yes No

A bank of two public telephones. The accessible telephone is on the left and the telephone on the right is equipped with a TTY.

J. Drinking Fountains

Approximately 50% of the drinking fountains serving the shelter must be accessible and located on an accessible route. Accessible drinking fountains must have enough space for a person using a wheelchair, scooter, or other mobility device to use the drinking fountain. The spout and controls of the drinking fountain must be near the front edge. The controls must be usable with one hand without tight grasping, pinching, or twisting of the wrist. The other 50% of drinking fountains serving the shelter must be configured for use by people who have difficulty bending or stooping while standing.

When an object, such as a drinking fountain, protrudes more than four inches into the circulation path, the bottom edge must be at 27 inches above the floor or lower so the drinking fountain is not a hazard to people who are blind or have low vision.

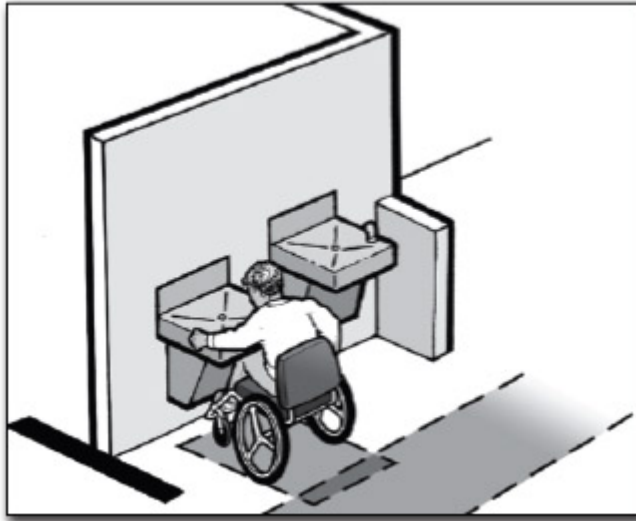

A person who uses a wheelchair is drinking from an accessible drinking fountain. Beside the accessible drinking fountain is a standard height fountain that is usable by people who have difficulty bending or stooping. The short wall beside the standard height drinking fountain is cane-detectable to guide people who are blind or have low vision away from the standard height fountain which, otherwise, would be a protruding object hazard.

The following questions apply to 50% of the drinking fountains that are provided.

J1. If the drinking fountain is a wall-mounted unit, is there clear floor space at least 30 inches wide (36 inches if it is in an alcove) x 48 inches long in front of the drinking fountain and at least 27 inches high under the fountain so that a person using a wheelchair can get close to the spout and controls? [ADA Standards § 4.15.5 (1), Figs. 4 (e) and 27 (b)]

Yes

No

J2. If the drinking fountain is a floor-mounted unit, is there clear floor space at least 30 inches long x 48 inches wide (60 inches if it is in an alcove) for a side approach to the drinking fountain so that a person using a wheelchair can get close to the spout and

controls even though the fountain has no clear space under it? [ADA Standards § 4.15.5 (2), Figs. 4 (e), 27 (c) and (d)]

Yes

No

J3. Is the top of the spout no higher than 36 inches above the floor and at the front of the fountain or water cooler? [ADA Standards § 4.15.2]

Yes

No

J4. Does the water rise at least 4 inches high when no more than 5 pounds of force is applied to the controls of the fountain? [ADA Standards §§ 4.15.3 and 4.15.4]

Yes

No

J5. Are the controls on or near the front of the unit and do they operate with one hand without tight grasping, pinching, or twisting of the wrist? [ADA Standards § 4.15.4]

Yes

No

J6. Is the bottom of the apron of the fountain 27 inches above the floor so that it provides the space needed for a person who uses a wheelchair to pull up under it but is not a hazard to people who are blind or have low vision and use a cane to detect hazards? [ADA Standards §§ 4.15.5 (1) and 4.4.1]

Yes

No

K. Eating Areas

An accessible route, at least 36 inches wide and without steps or steep slopes, must be provided to and throughout the food service and eating areas of the shelter. The accessible route allows people who use wheelchairs, scooters, and other mobility devices to get to all of the food and drink items in the shelter and to accessible tables and seating.

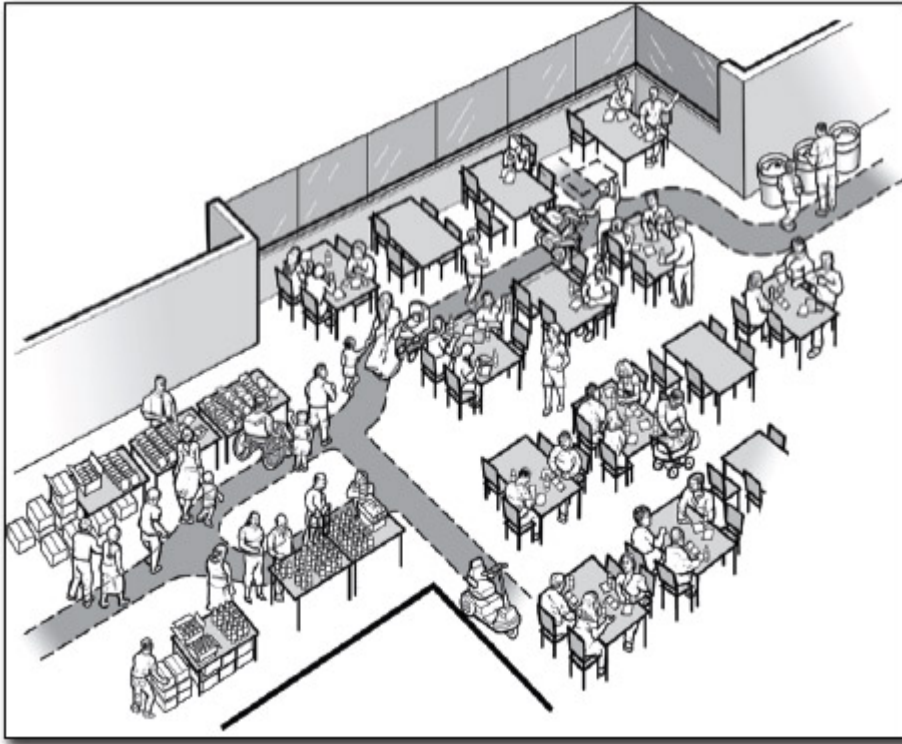

A serving and eating area in a shelter are shown above. The shaded pathway illustrates the accessible route connecting the entrance, serving areas, accessible seats and tables, and the exit.

K1. Is there an accessible route, at least 36 inches wide, that connects each of the shelter activity areas with the food service and eating areas (it may narrow to 32 inches wide for up to 2 feet in length)? [ADA Standards § 4.3.2(3)]

Yes No

K2. Is there an accessible route that is at least 36 inches wide that connects accessible tables with serving, condiment, and dispenser areas? [ADA Standards § 5.3; 4.3.8]

 Yes No

K3. In each eating area, if tables with fixed seats are provided, do at least 5% of each type of table with fixed seats have accessible locations with knee space at least 27 inches high, at least 19 inches deep, and at least 30 inches wide with a table top 28 to 34 inches above the floor? [ADA Standards § 5.1]

 Yes No

Note: If movable tables and chairs are used as shown, then locate at least 5% of the tables adjacent to an accessible route. Tables can be relocated as needed during operation of the shelter.

K4. If built-in food, drink, condiment, and tableware dispensers are provided, are dispensers and operating controls mounted no higher than 54 inches above the floor if clear floor space is provided for a side approach? [ADA Standards § 5.5]

 Yes No

K5. If the operating controls are set back 10 to 24 inches from the front edge of the counter or table are they no higher than 46 inches above the floor? [ADA Standards § 5.5]

 Yes No

K6. If food service lines are provided, is an accessible route provided (at least 36 inches wide) and are the tray slides no higher than 34 inches above the floor? [ADA Standards § 5.5]

Yes

No

Other Issues

L. Availability of Electrical Power

Emergency shelters should have a way to provide a back-up power supply when the electrical service is interrupted. The back-up power is needed to provide refrigeration of medicines, operation of supplemental oxygen and breathing devices, and for charging the batteries of power wheelchairs and scooters. Individuals whose medications (certain types of insulin, for example) require constant refrigeration need to know if a shelter provides supplemental power for refrigerators or ice-packed coolers. Individuals who use medical support systems, such as supplemental oxygen, or who require periodic breathing treatments using powered devices rely on a stable source of electricity. These individuals must have access to electric power from a generator or other source of electricity while at a shelter.

In general, in each community or area where a shelter is provided, a facility must have one or more back-up generators or other sources of electricity so that evacuees with a disability who rely on powered devices can have access to electrical power while at the shelter.



L1. Is there a backup source of electrical power for the facility?

Yes No

L2. Is there a refrigerator or other equipment, such as coolers with a good supply of ice, at the shelter?

 Yes No

M. Single-User or “Family” Toilet Room

In many schools and large facilities where emergency shelters are often located, single-user toilet rooms may be provided for staff. In those facilities built or altered since the ADA went into effect, single-user toilet rooms should have accessible features that could be useful during shelter operation. These features include an accessible entrance and turning and maneuvering spaces. These rooms should also have been built to allow grab bars, accessible controls, and accessible hardware to be easily installed.

As part of the planning for operating an emergency shelter, facilities operators should consider using an available staff toilet room, if provided, as a single-user or “family” toilet room. When provided in addition to large accessible toilet rooms, this type of facility permits a person with a disability to receive assistance from a person of the opposite sex.

M1. If a sign is provided at the toilet room entrance (e.g. Men, Women, Boys, Girls, etc.), is a sign with raised characters and Braille mounted on the wall adjacent to the latch side of the door and centered 60 inches above the floor? [ADA Standards § 4.1.3(16)(a)]

 Yes No

If No, install a sign with raised characters and Braille on the wall adjacent to the latch side of the door and centered 60 inches above the floor and leave the existing sign in place on the door if removing it will damage the door.

Note: an additional sign may be mounted on the toilet room door but this cannot be considered to be the accessible sign which must be mounted on the wall adjacent to the latch side of the door.

M2. Does the door to the toilet room provide at least 32 inches clear passage width when the door is open 90 degrees? [ADA Standards § 4.13.5]

Yes

No

M3. Is the hardware (e.g., lever, pull, etc.) usable with one hand without tight grasping, pinching, or twisting of the wrist? [ADA Standards § 4.13.9]

Yes

No

If No, add new accessible hardware or adapt/replace hardware.

M4. On the latch, pull side of the door, is there at least 18 inches clearance provided if the door is not automatic or power operated? [ADA Standards § 4.13.6; Fig. 25]

Yes

No

M5. If there is a raised threshold, is it no higher than 3/4 inch at the door and beveled on both sides? [ADA Standards §§ 4.1.6(3)(d)(ii); 4.13.8]

Yes

No

If No, replace threshold with one with beveled sides or add a sloped insert.

M6. Inside the room is there an area for a person who uses a wheelchair to turn around - either a 60-inch diameter circle or a "T"-shaped turn area? [ADA Standards §§ 4.22.3; 4.2.3]

Yes

No

M7. If the door swings into the room, does the door swing not overlap the required clear floor space for the toilet or lavatory? [ADA Standards §§ 4.22.2; 4.2.4.1]

 Yes No

Note: In the figure below the clear floor space for the toilet extends at least 66 inches from the back wall.

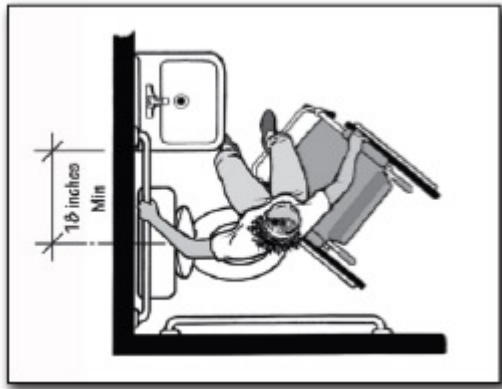

Plan view showing the minimum amount of space required between the toilet and the adjacent lavatory.

M8. Is there at least 18 inches between the center of the toilet and the side of the adjacent lavatory? [ADA Standards § 4.16.2; Fig. 28]

 Yes No

M9. Does the lavatory have at least a 29-inch-high clearance under the front edge and the top of the rim no more than 34 inches above the floor? [ADA Standards § 4.19.2]

Yes

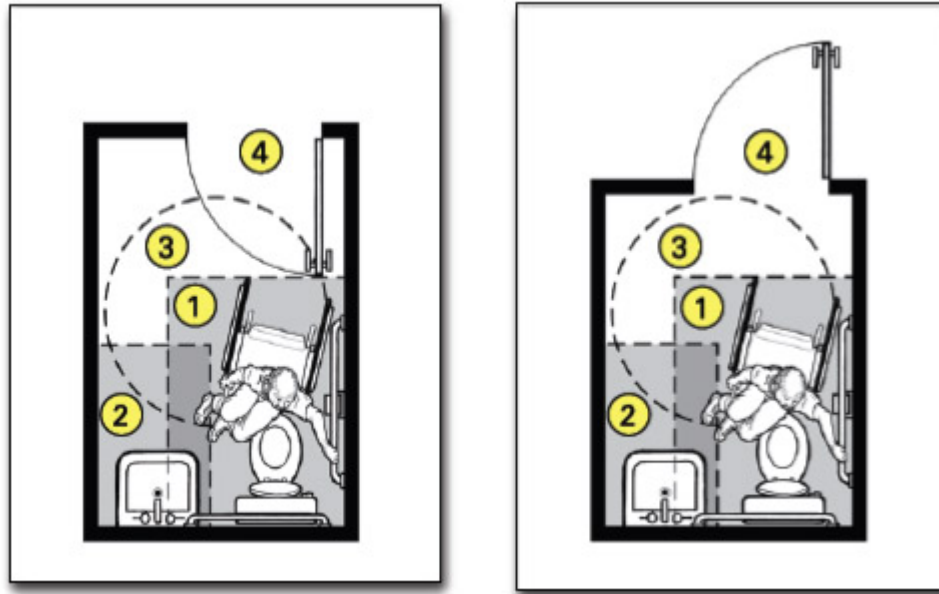
 No

Plan view of a single-user toilet room showing the door swing not overlapping the dark toned area indicating the clear floor space for the toilet and lavatory. The door swing may overlap the turning space indicated by the circular area.

Notes:

1. 48-inch minimum by 66-inch minimum clear floor space for toilet
2. 48-inch minimum by 30-inch minimum clear floor space for lavatory
3. 60-inch minimum turning space
4. door swing

M10. Are the drain and hot water pipes for the lavatory insulated or otherwise configured to protect against contact? [ADA Standards § 4.19.4]

Yes No

M11. Does that lavatory have controls that operate easily with one hand, without tight grasping, pinching, or twisting of the wrist? [ADA Standards § 4.19.5]

 Yes No

M12. If a mirror is provided, is the bottom of the reflecting surface no higher than 40 inches above the floor or is a full length mirror provided? [ADA Standards § 4.19.6]

 Yes No

M13. For each type of dispenser, receptacle, or equipment, is there clear floor space at least 30 inches wide x 48 inches long adjacent to the control or dispenser (positioned either parallel to the control or dispenser or in front of it)? [ADA Standards §§ 4.23.7; 4.27.2; 4.2.5 and Fig. 5; 4.2.6 and Fig. 6]

 Yes No

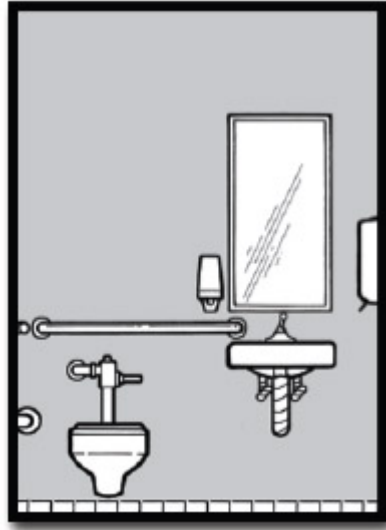

front view of toilet, lavatory, mirror
and soap dispenser

M14. Is the operating control (switch, lever, button, or pull) for each type of dispenser or built-in equipment no higher than 54 inches above the floor (if there is clear floor space for a parallel approach) or 48 inches (if there is clear floor space for a front approach)? [ADA Standards §§ 4.23.7; 4.27.3; 4.2.5 and Fig. 5; 4.2.6 and Fig. 6]

Yes

No

M15. Are all built-in dispensers, receptacles, or equipment mounted so the front does not extend more than 4 inches from the wall if the bottom edge is between 27 inches and 80 inches above the floor? [ADA Standards §§ 4.23.7; 4.27; 4.4.1; Fig. 8]

Yes

No

M16. Is the centerline of the toilet 18 inches from the adjacent side wall? [ADA Standards §§ 4.16.2; 4.17.3]

Yes

No

M17. Is the top of the toilet seat 17 to 19 inches above the floor? [ADA Standards § 4.16.3]

Yes

No

M18. Is the flush valve located on the side adjacent to the lavatory? [ADA Standards § 4.16.5]

Yes

No

M19. Is a horizontal grab bar at least 40 inches long securely mounted on the adjacent side wall 33 to 36 inches above the floor with one end no more than 12 inches from the back wall? [ADA Standards §§ 4.16.4; 4.17.6]

Yes

No

M20. Is there a horizontal grab bar at least 36 inches long securely mounted behind the toilet 33 to 36 inches above the floor with one end no more than 6 inches from the side wall? [ADA Standards §§ 4.16.4; 4.17.6]

Yes

No

M21. If a coat hook is provided, is it mounted no higher than 54 inches above the floor for a side approach or 48 inches above the floor for a front approach? [ADA Standards § 4.25.3]

Yes

No

N. Health Units/Medical Care Areas

In many schools, where emergency shelters are often located, nurses' rooms or other types of health care facilities may be provided. These health care facilities should be on an accessible route and have accessible features, including an accessible entrance, an accessible route to the different types of services offered within the medical care unit, turning and maneuvering spaces, and cots or beds that are at a height to which people who use mobility devices can easily transfer.

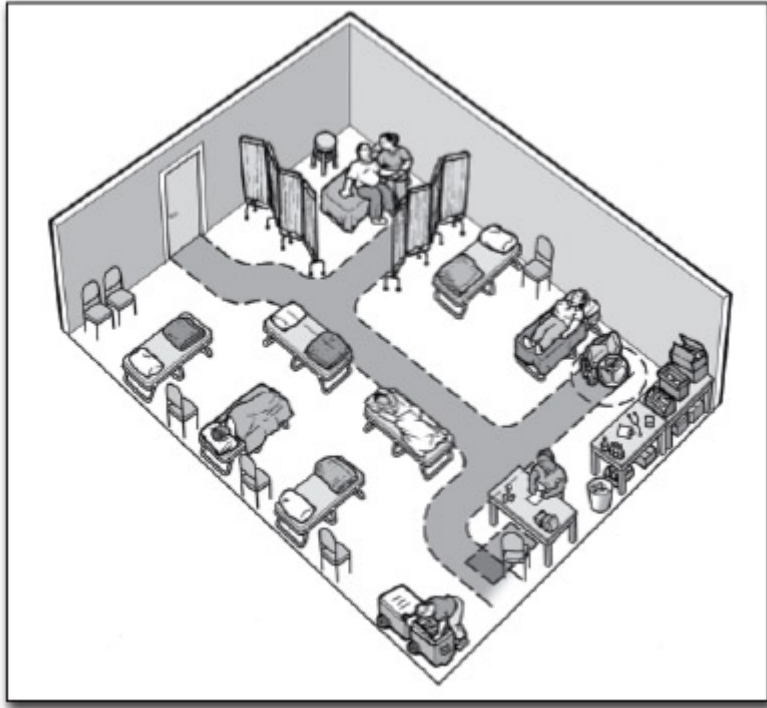

An overhead view of a medical care area with a shaded pathway showing the accessible route shown and clear floor spaces.

N1. Is there an accessible route, at least 36 inches wide, that connects each of the shelter activity areas with the health units and medical care areas (it may narrow to 32 inches wide for up to 2 feet in length)? [ADA Standards § 4.3.2(3)]

Yes

No

O. Accessible Portable Toilets

Portable toilets are often used at emergency shelters to supplement permanent toilet facilities. When portable toilets are provided, at least one must be a unit with accessible features that is located on an accessible route connecting it with the shelter. For the entrance to an accessible portable toilet to be usable, there must either be no step or a ramp must be installed that extends from the hinge side of the door to at least 18 inches beyond the latch side of the door.

Accessible portable toilets should have similar features to a standard accessible toilet stall including an accessible door, side and rear grab bar, clear space next to the toilet, and maneuvering space.

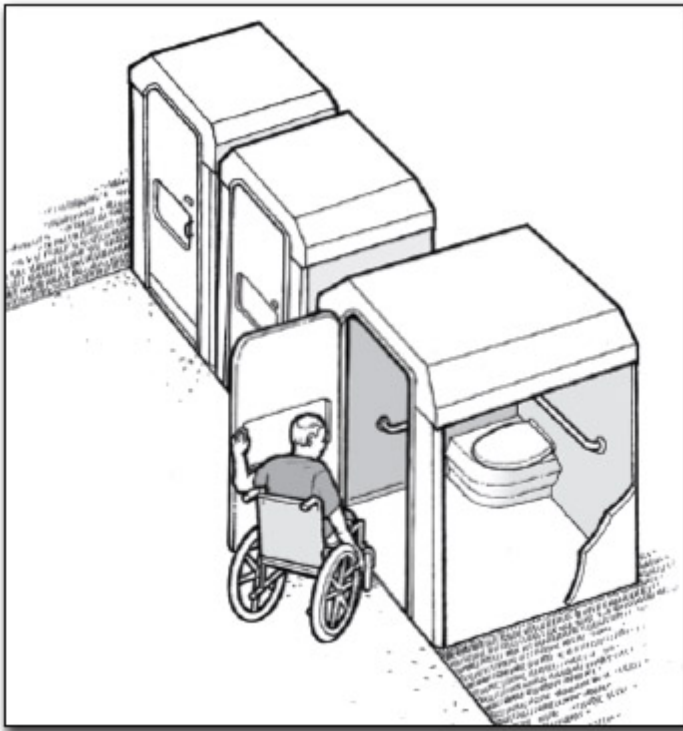

A person using a wheelchair enters an accessible portable toilet. The unit is positioned to provide a level entry from the accessible route.

The Americans with Disabilities Act authorizes the Department of Justice (the Department) to provide technical assistance to individuals and entities that have rights or responsibilities under the Act. This document provides informal guidance to assist you in understanding the ADA and the Department's regulations.

This guidance document is not intended to be a final agency action, has no legally binding effect, and may be rescinded or modified in the Department's complete discretion, in accordance with applicable laws. The Department's guidance documents, including this guidance, do not establish legally enforceable responsibilities beyond what is required by the terms of the applicable statutes, regulations, or binding judicial precedent.

[ADA Tool Kit for State and Local Governments](#)

December 14, 2010